

# LORIN NIGHTSTAND

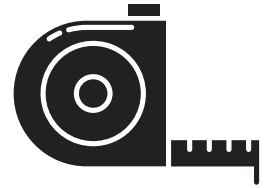

**A\*12**

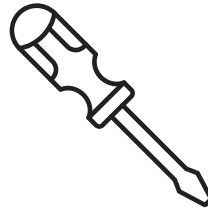
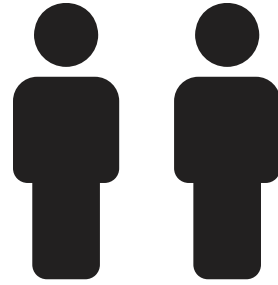
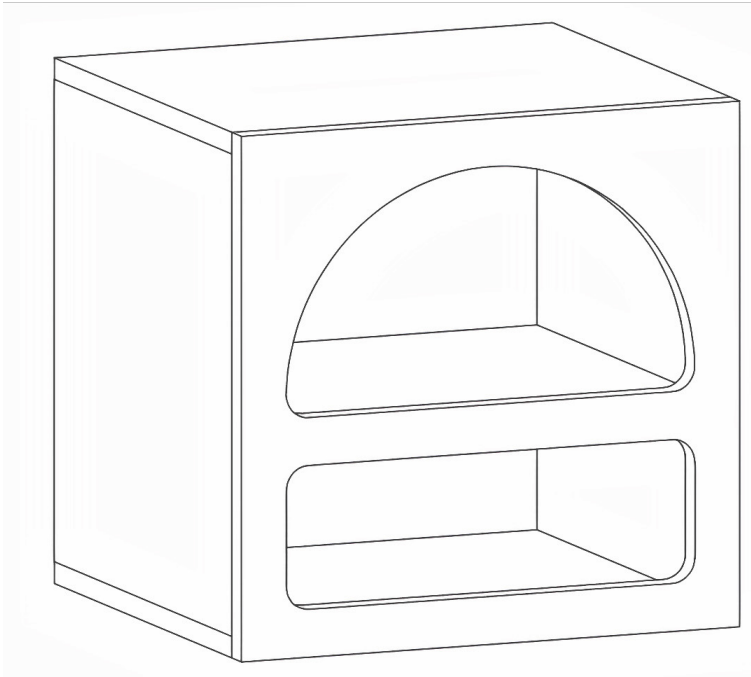
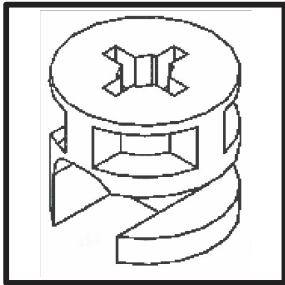

**B\*12**

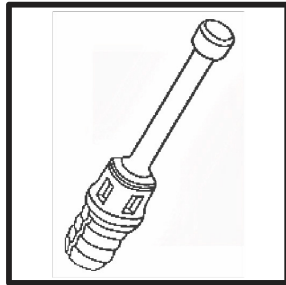

**C\*12**

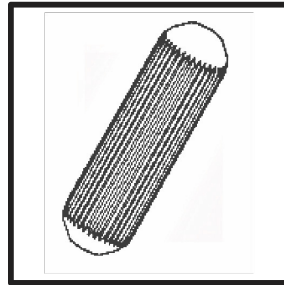

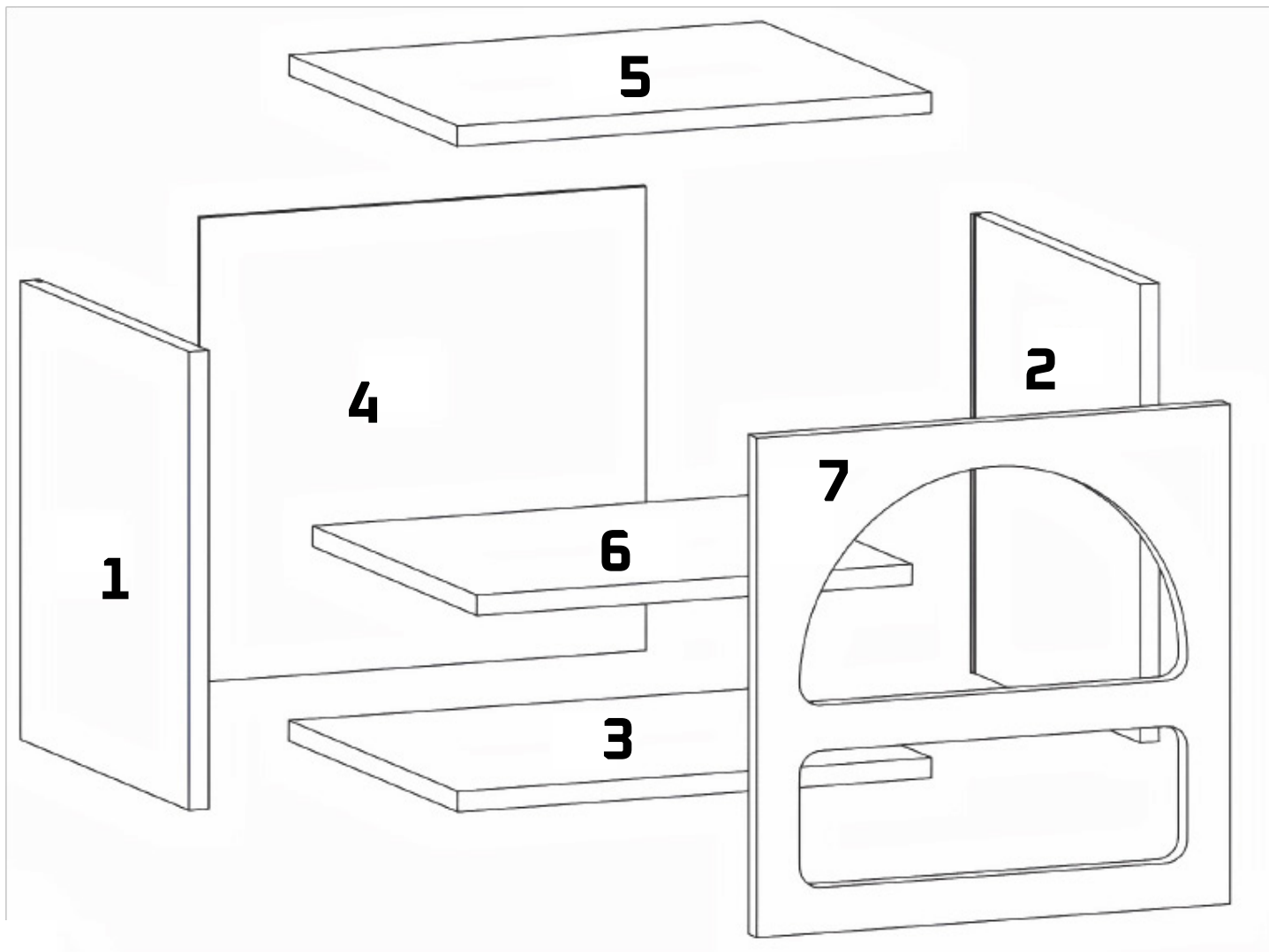

## **MATERIAL DIMENSIDN INFDRMATIDN**

- 1) 464\*380 18MM LEFT PANEL**
- 2) 464\*380 18MM RIGHT PANEL**
- 3) 500\*380 18MM BOTTOM PANEL**
- 4) BACKREST**
- 5) 500\*380 18MM TOP PANEL**
- 6) 464\*365 18MM FIXED SHELF 7)**
- 500\*500 18MM LORIN COVER**

