

# LESSA CONSOLE

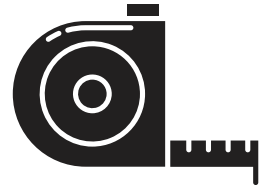

**A\*25**

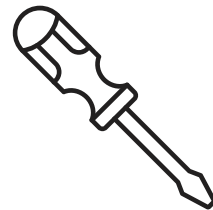
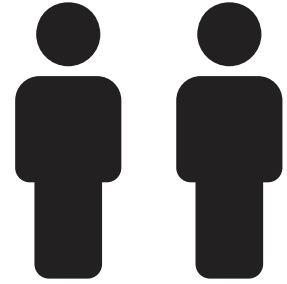
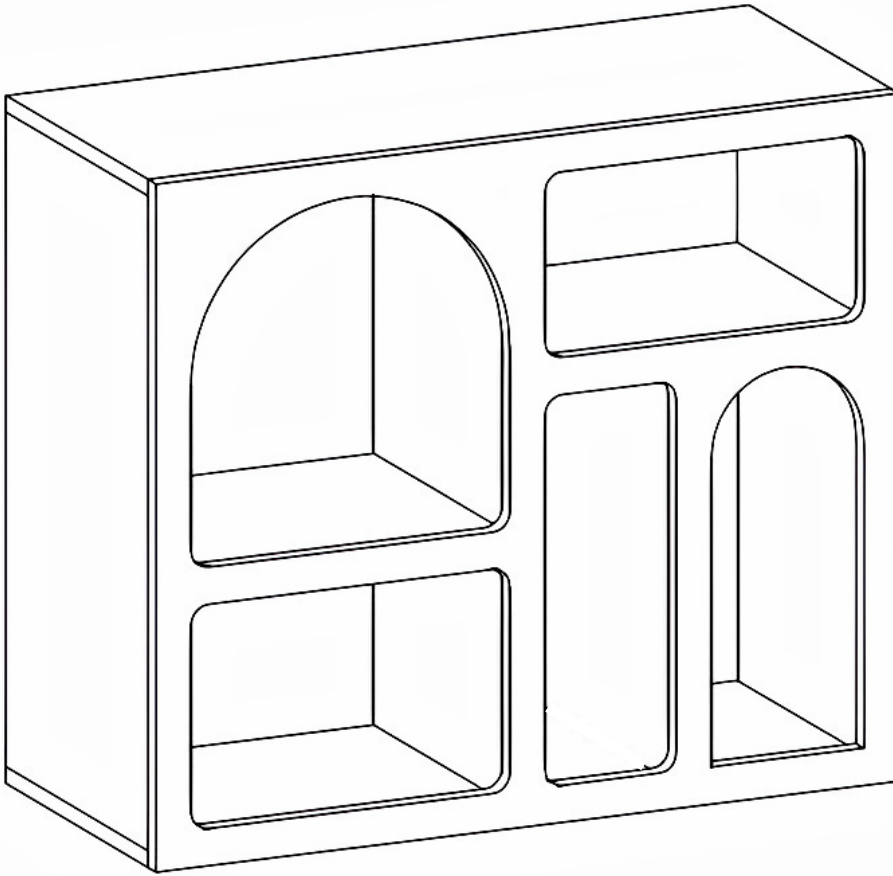
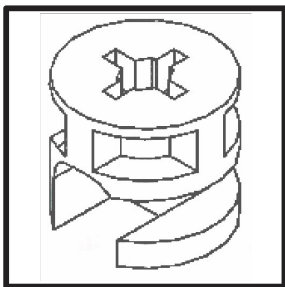

**B\*25**

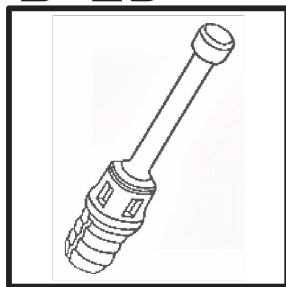

**C\*20**

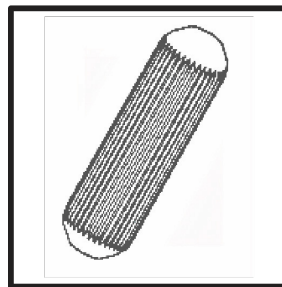

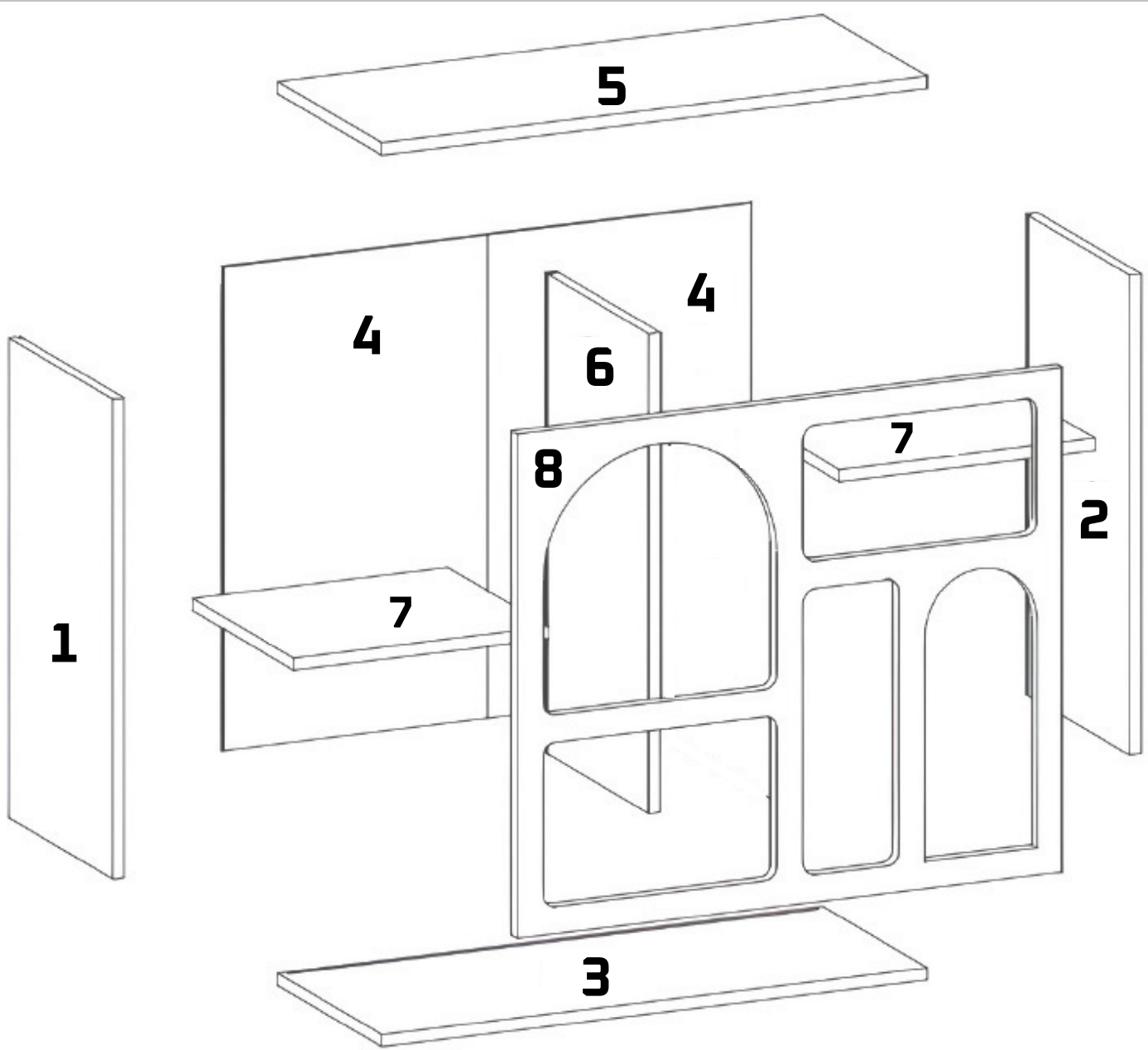

## **MATERIAL DIMENSIDN INFDRMATIDN**

- 1) 704\*350 18MM LEFT PANEL**
- 2) 704\*350 18MM RIGHT PANEL**
- 3) 800\*350 18MM BOTTOM  
PANEL**
- 4) BACKREST**
- 5) 800\*350 18MM TOP PANEL**
- 6) 704\*350 18MM STRUT**
- 7) 373\*335 18MM FIXED SHELF**
- 8) 800\*740 18MM LESSA COVER**

