

# LACİVERT MİMARLIK

---

AYAKKABILIK L1187 / SHOE CABINET L1187



# DİKKAT !

---

Değerli Müşterimiz,  
Satın almış olduğunuz ürünü eksiksiz ve kolayca kurabilmeniz için hazırlamış olduğumuz klavuzu dikkatlice ve sırasıyla uygulamanızı öneririz.

Öncelikle teslim aldığınız paketi açıp, parça ve aksesuar listesinden inceleyerek gelen parçaları kontrol ediniz.

Kontrol işlemini gerçekleştirdikten sonra adımları sırasıyla, verilen aksesuarları kullanarak yapınız.

Montaj aşamasında herhangi bir problem yaşamamanız açısından aksesuar listesindeki malzeme miktarları gereğinden fazla gönderilmiştir. Malzeme artması durumunda eksik birleşim yapma endişesi duymayınız.

Sizlere verdiğimiz hizmeti özenerek ve dikkatle yapmaktayız fakat herhangi bir sorun durumunda bize ulaşabilirsiniz.

İletişim Bilgileri:

 siparis@reklamcivert.com

# ATTENTION!

---

Dear customer,  
We recommend that you follow the carefully prepared field guide so that you can assemble the product you have purchased completely and easily.

First of all, check the incoming parts by opening the package you received, examining the parts and accessories list.

After performing the control process, perform the steps one by one using the accessories provided.









In order to avoid any problems during the assembly phase, the amount of material in the accessory list has been sent more than necessary. Do not worry about missing joints in case of increased material.

We work with care, but if there is any problem, you can call.







Contact Information:

 siparis@reklamcivert.com

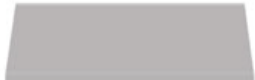
# AKSESUAR LİSTESİ / ACCESSORY LIST

|   |  |  |  |   |
|---|--|--|--|---|
| <p>3,5 x 18 Vida x40</p>  <p><b>A07</b></p> | <p>Menteşe (Süper Deve) x4</p>  <p><b>C02</b></p> | <p>Qfix Vidası x24</p>  <p><b>A15</b></p> | <p>Qfix Aparatı x24</p>  <p><b>A16</b></p> | <p>Dolap Ayağı x4</p>  <p><b>D05</b></p>   |
| <p>Askı Aparatı x2</p> <p><b>B08</b></p>  | <p>Kulp Vidası x2</p>  <p><b>A06</b></p>          | <p>Topuz Kulp x2</p>  <p><b>A06</b></p>   | <p>Dübel x4</p>  <p><b>A06</b></p>         | <p>3,5 x 50 Vida x4</p>  <p><b>A06</b></p> |

# PARÇA LİSTESİ / COMPONENT LIST

|  |   |  |  |  |
|--|---|--|--|--|
| <p>P1-P2<br/>37,8X75,9 cm</p> <p>x2</p>  | <p>P3-P4<br/>80x40 cm</p> <p>x2</p>       | <p>P5-P6<br/>76,4x40 cm</p> <p>x2</p>  | <p>P7 - Arkalık<br/>78x78 cm</p> <p>x1</p>  | <p>P8-P9<br/>36x76,4 cm</p> <p>x2</p>  |
| <p>P10-P11<br/>20x80 cm</p> <p>x2</p>    | <p>P12-P13<br/>20x16,4 cm</p> <p>x2</p>  | <p>P14<br/>18x78 cm</p> <p>x1</p>     |  |  |

# PARÇA TANILAMA / GENERAL VIEW

---

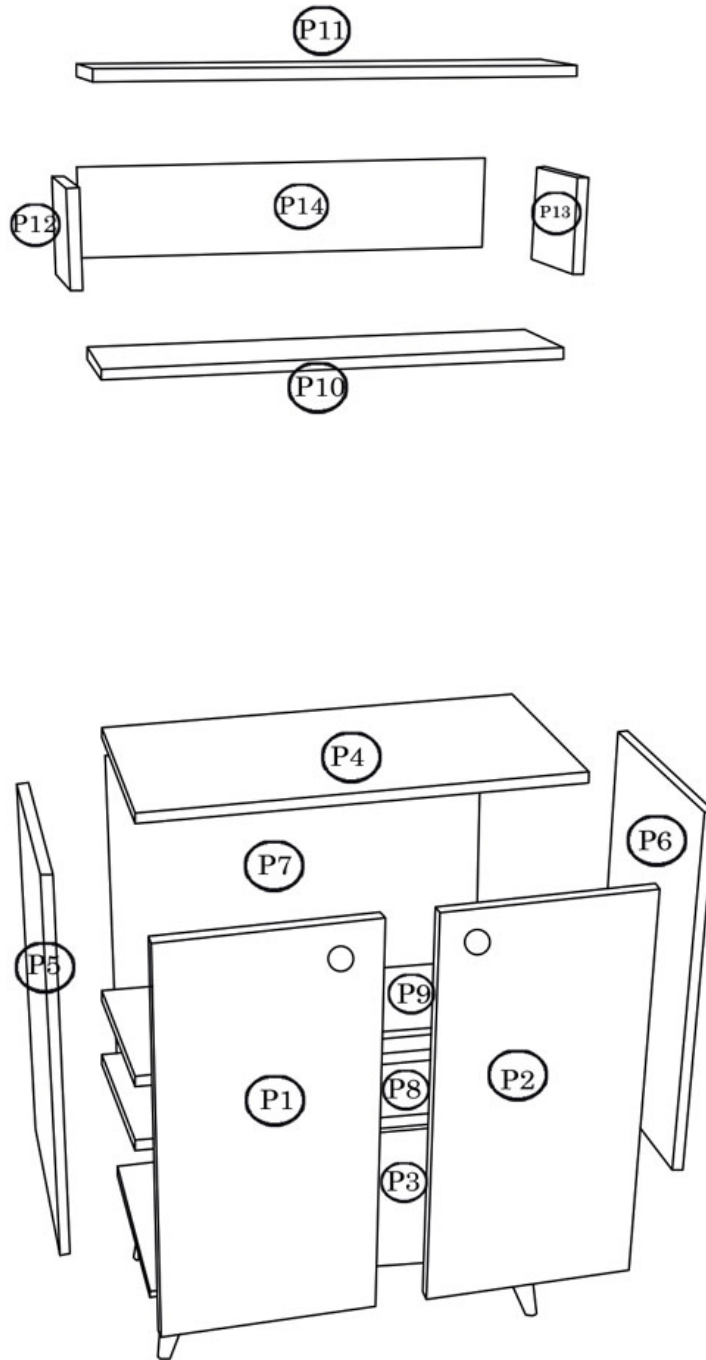

1

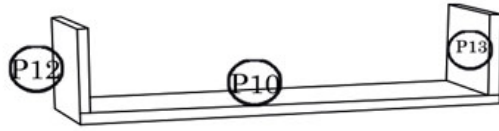

A15

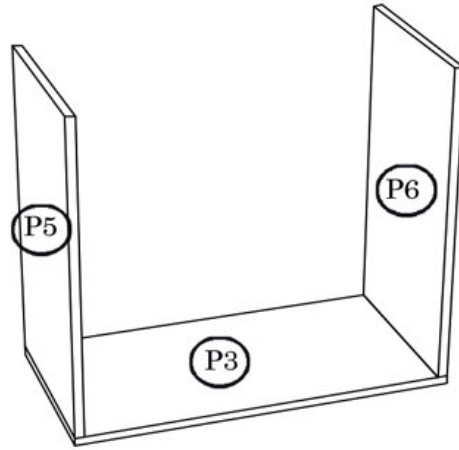
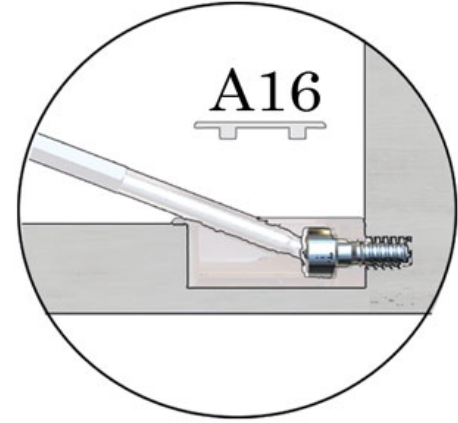

2

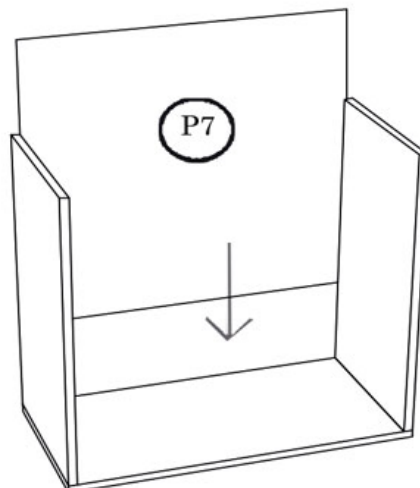
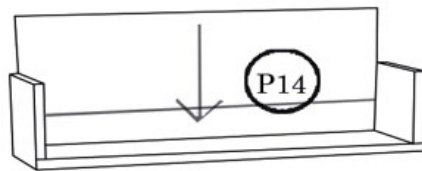

3

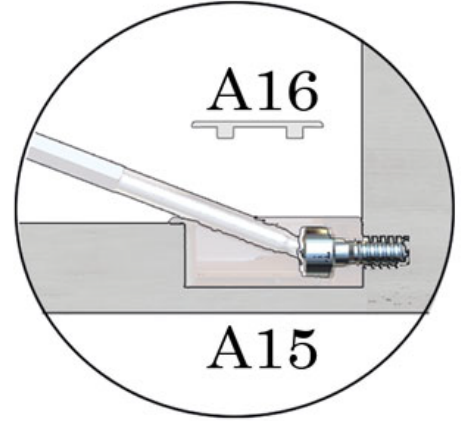
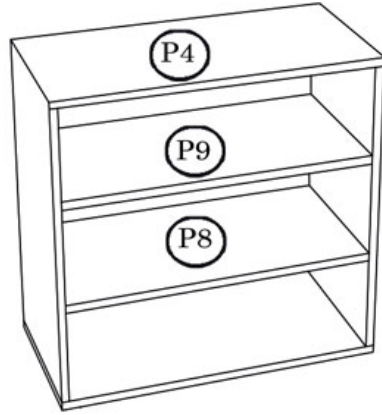
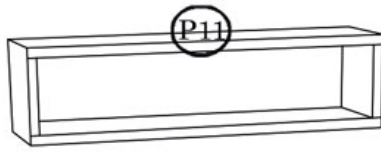

4

