

LACİVERT MİMARLIK

GARDIROP / GARDROBE L638



DİKKAT !

Değerli Müşterimiz,
Satın almış olduğunuz ürünü eksiksiz ve kolayca kurabilmeniz için hazırlamış olduğumuz klavuzu dikkatlice ve sırasıyla uygulamanızı öneririz.

Öncelikle teslim aldığınız paketi açıp, parça ve aksesuar listesinden inceleyerek gelen parçaları kontrol ediniz.

Kontrol işlemini gerçekleştirdikten sonra adımları sırasıyla, verilen aksesuarları kullanarak yapınız.

Montaj aşamasında herhangi bir problem yaşamamanız açısından aksesuar listesindeki malzeme miktarları gereğinden fazla gönderilmiştir. Malzeme artması durumunda eksik birleşim yapma endişesi duymayınız.

Sizlere verdiğimiz hizmeti özenerek ve dikkatle yapmaktayız fakat herhangi bir sorun durumunda bize ulaşabilirsiniz.

İletişim Bilgileri:

✉ siparis@reklamlacivert.com

ATTENTION!

Dear customer,
We recommend that you follow the carefully prepared field guide so that you can assemble the product you have purchased completely and easily.

First of all, check the incoming parts by opening the package you received, examining the parts and accessories list.

After performing the control process, perform the steps one by one using the accessories provided.







In order to avoid any problems during the assembly phase, the amount of material in the accessory list has been sent more than necessary. Do not worry about missing joints in case of increased material.

We work with care, but if there is any problem, you can call.











Contact Information:

✉ siparis@reklamlacivert.com

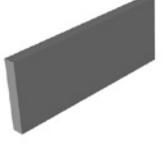
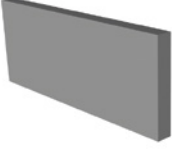
AKSESUAR LİSTESİ / ACCESSORY LIST

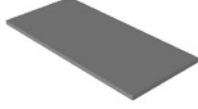
4x 35 Vida  x25 1 No	Çekmece Ray  x4 2 No	Arkalık Çivisi  x30 6 No	3,5x18 Vida  x25 3 No
Qfix Vida  x26 4 No	Qfix Kapak  x26 5 No		

PARA LİSTESİ / ACCESSORY LIST

<p>P1- P2 EKMECE KAPAK 25,9X56,8 CM</p>  <p>x2</p>	<p>P3 - P4 ALT -ÜST PANEL 40,5x120 cm</p>  <p>x2</p>	<p>P5 - P6 - P8 DİKME SAĞ- SOL ORTA 40,5X26,4 cm</p>  <p>x3</p>	<p>P7 DOLAP ARKALIK 28X118 cm</p>  <p>x1</p>	<p>P9-P10-P13-P14 EKMECE YAN 30,7X32,4 cm</p>  <p>x4</p>
<p>P15 - P11 EKMECE ARKA 14,6X51,2 CM</p>  <p>x2</p>	<p>P12-P16 EKMECE ARKALIK 30X54,8 cm</p>  <p>x2</p>	<p>P17 ÜST RAF 40x120 cm</p>  <p>x1</p>	<p>P18 ORTA RAF 40,5x61 cm</p>  <p>x1</p>	<p>D1 DEMİR DİKME 45X180 cm</p>  <p>x1</p>
<p>D2-D3 DEMİR DİKME 45X180 cm</p>  <p>x2</p>	<p>D4 - D5 DEMİR ASKI 50X8 cm</p>  <p>x2</p>			

PARÇA TANILAMA / GENERAL VIEW

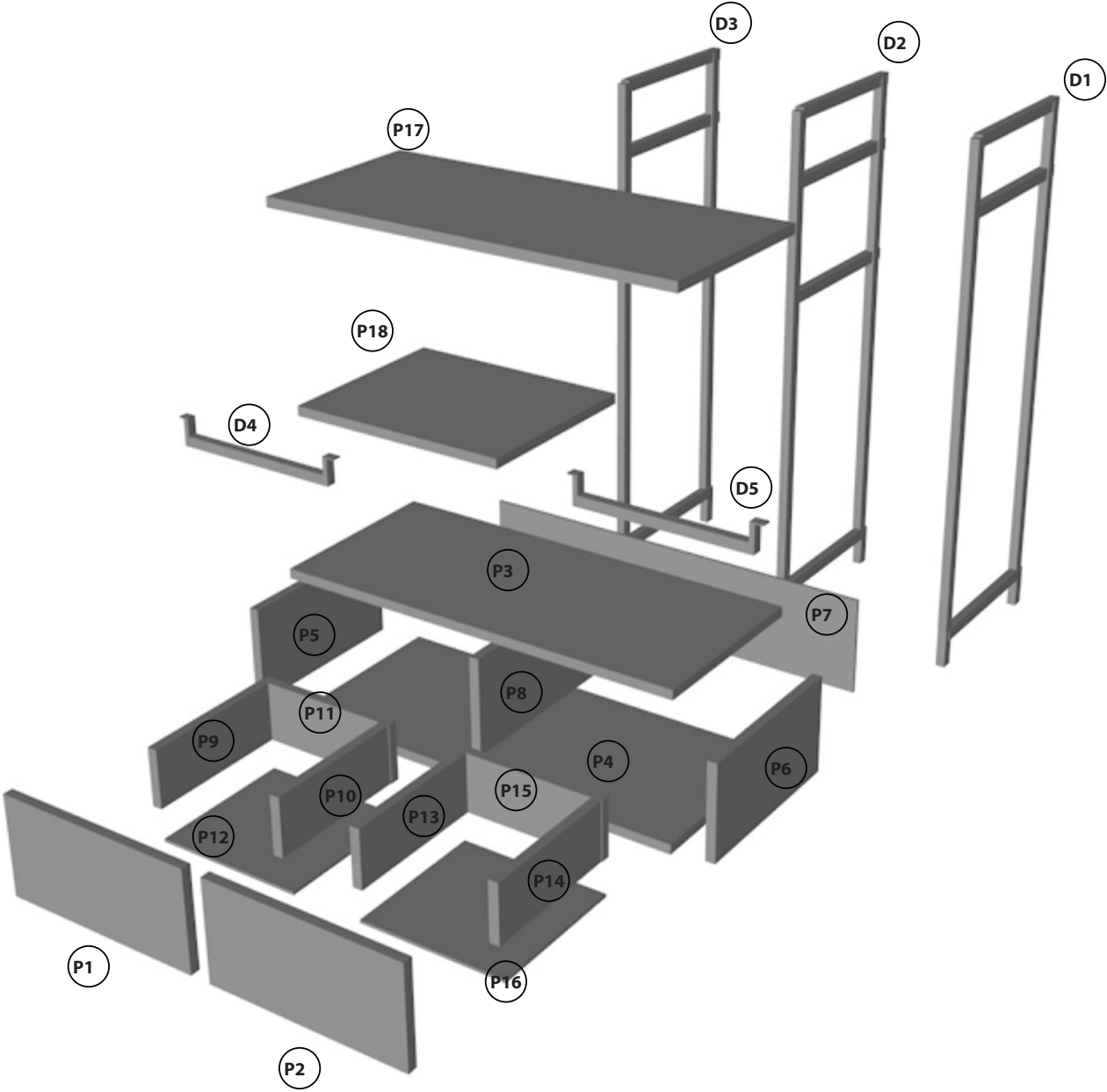

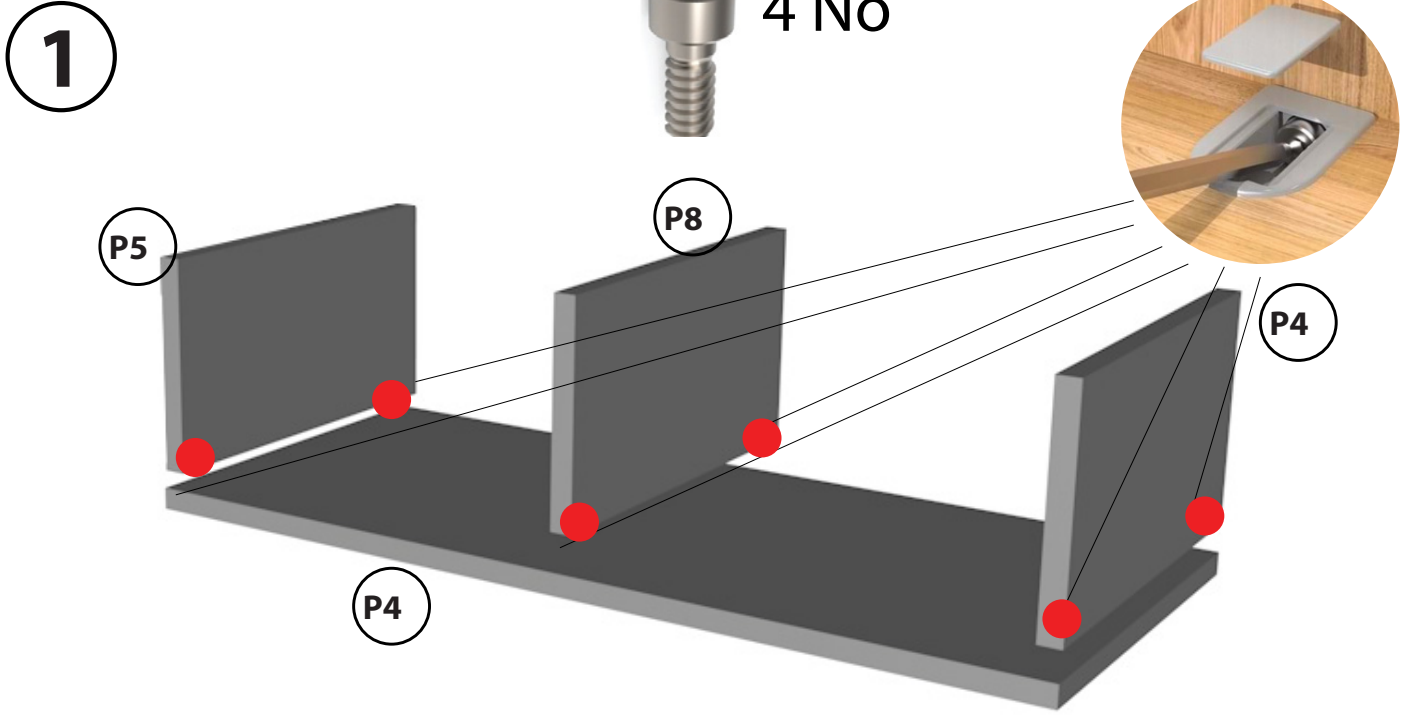

Not: 4 nolu vida ile parçaları birbirine montajlayınız .

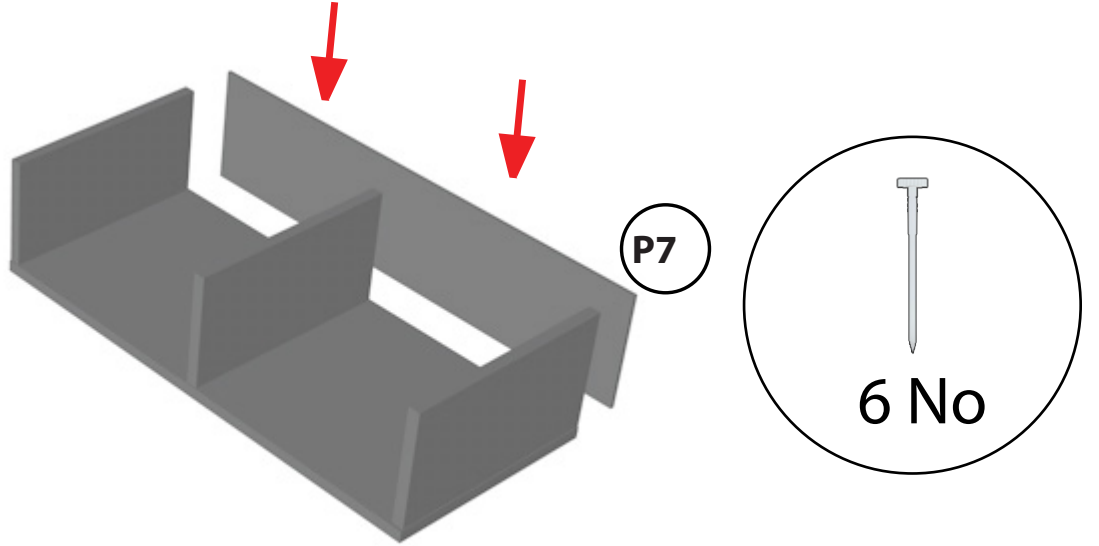

Not: ARKALIK ÇİVİSİ (6NO) İLE ARKALIĞI MONTAJ EDİNİZ

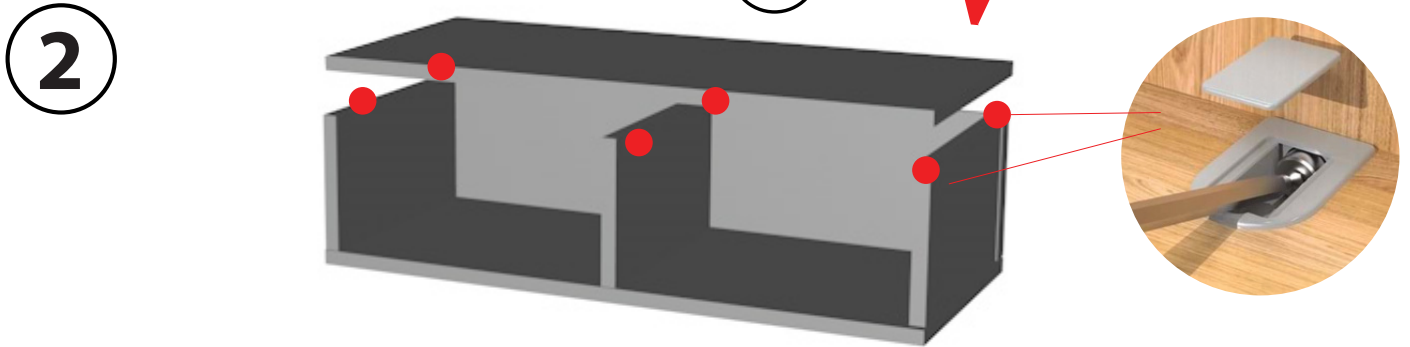

Not: ARKALIK MONTAJI SONRASI ÜST KAPAĞI QFIX VİDALAR İLE TAMAMLAYINIZ

3

ÇEKMECE TOPLAMA ŞEMASI



4 No

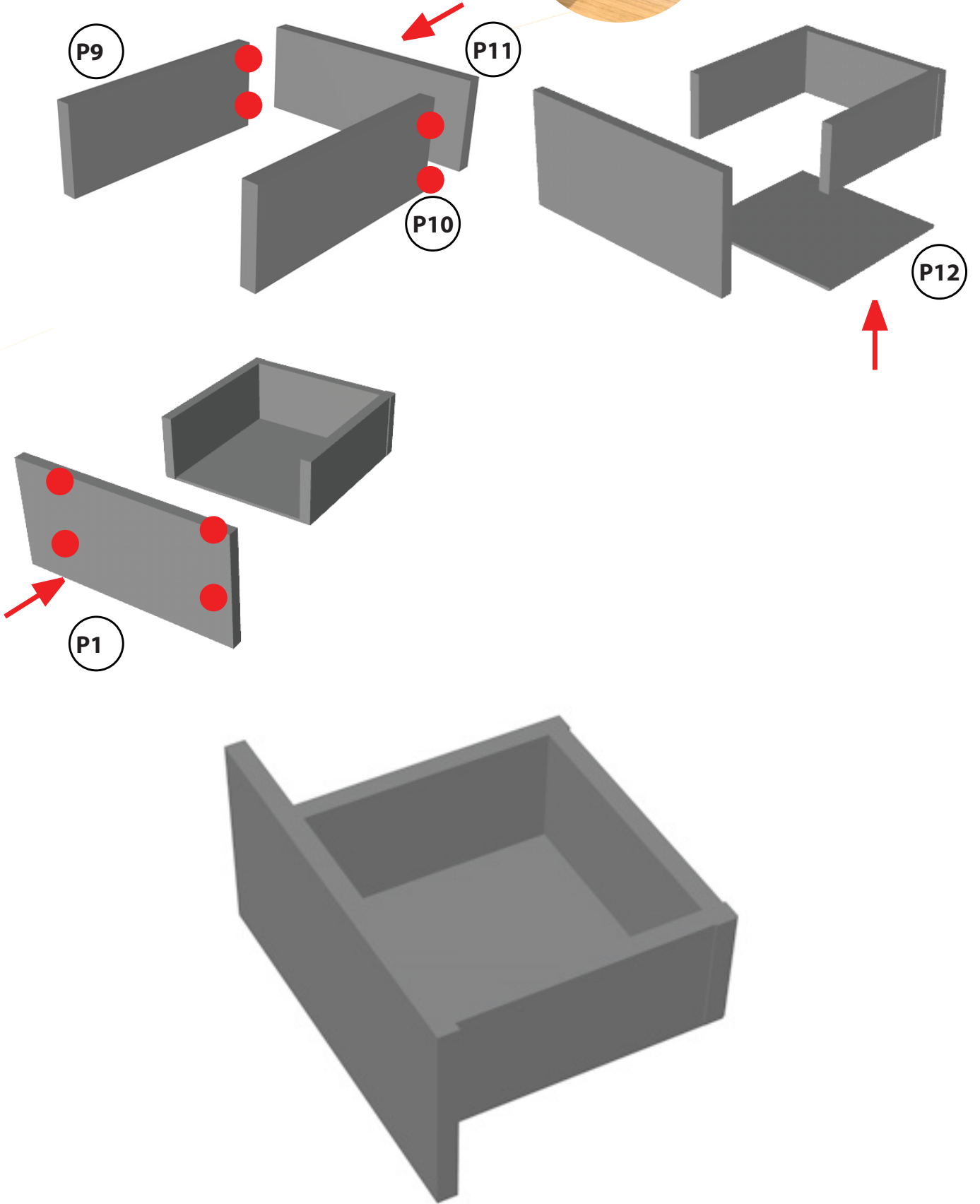

NOT : P11 PARÇASINA P9 VE P10 QFİX 4 NOLU VİDA İLE SABİTLEYİNİZ
ARDINDAN AYNI ŞEKİLDE P1(ÇEKMECE KAPAĞINI)QFİX
İLE SABİTLEYİNİZ.

4

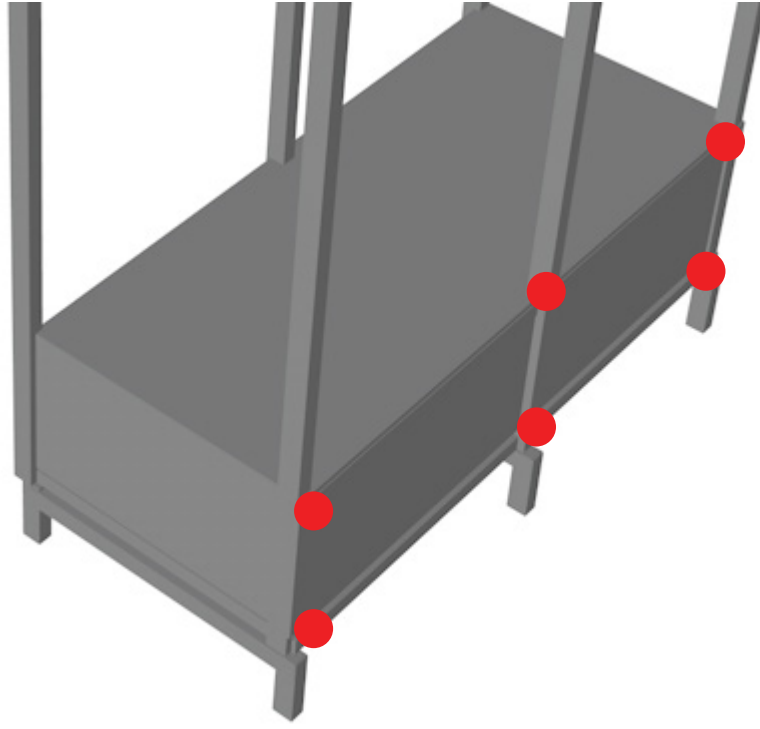

1 No

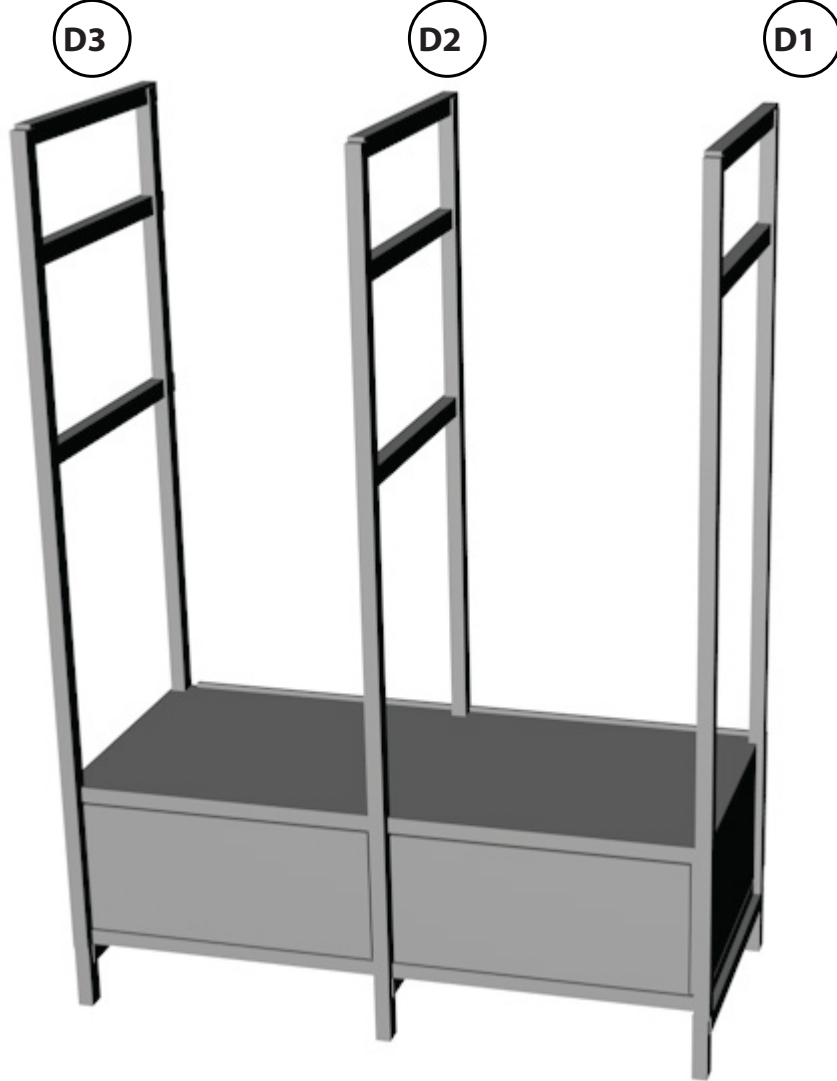

NOT : 1 NO (4X35 VİDA) İLE DEMİR PROFİLLERİ ALT MOBİLYA ÜZERİNE ARKADAN MONTAJLAYINIZ HER BİR PROFİLDE 2 DELİK BULUNMAKTADIR.

5

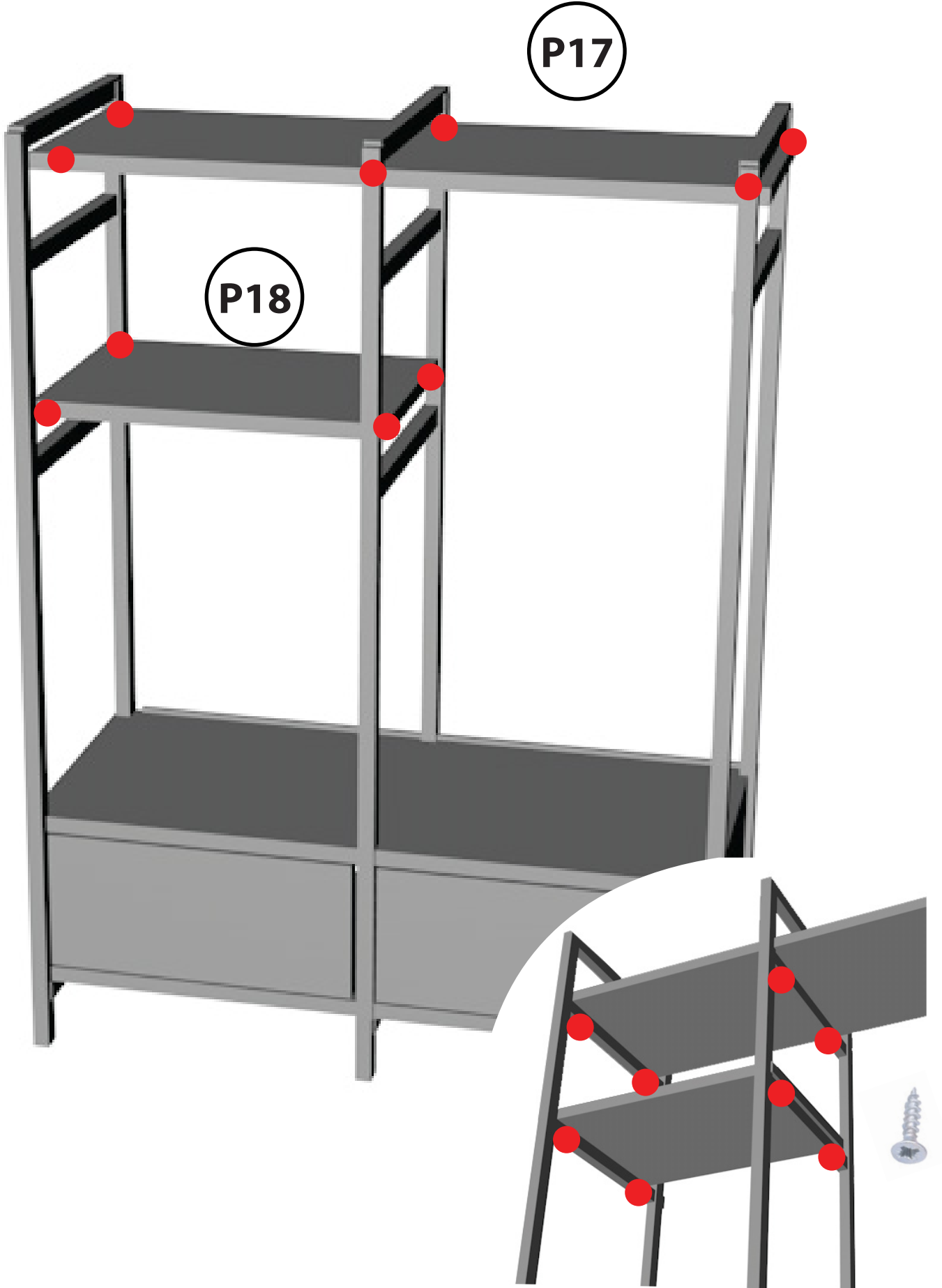

NOT : RAFLARI YERLEŐTİRDİKTEN SONRA PROFİL ALTLARINDAKİ DELİKLERDEN RAFLARI 1 NO(4X35 VİDA) İLE VİDALAYINIZ

7

