

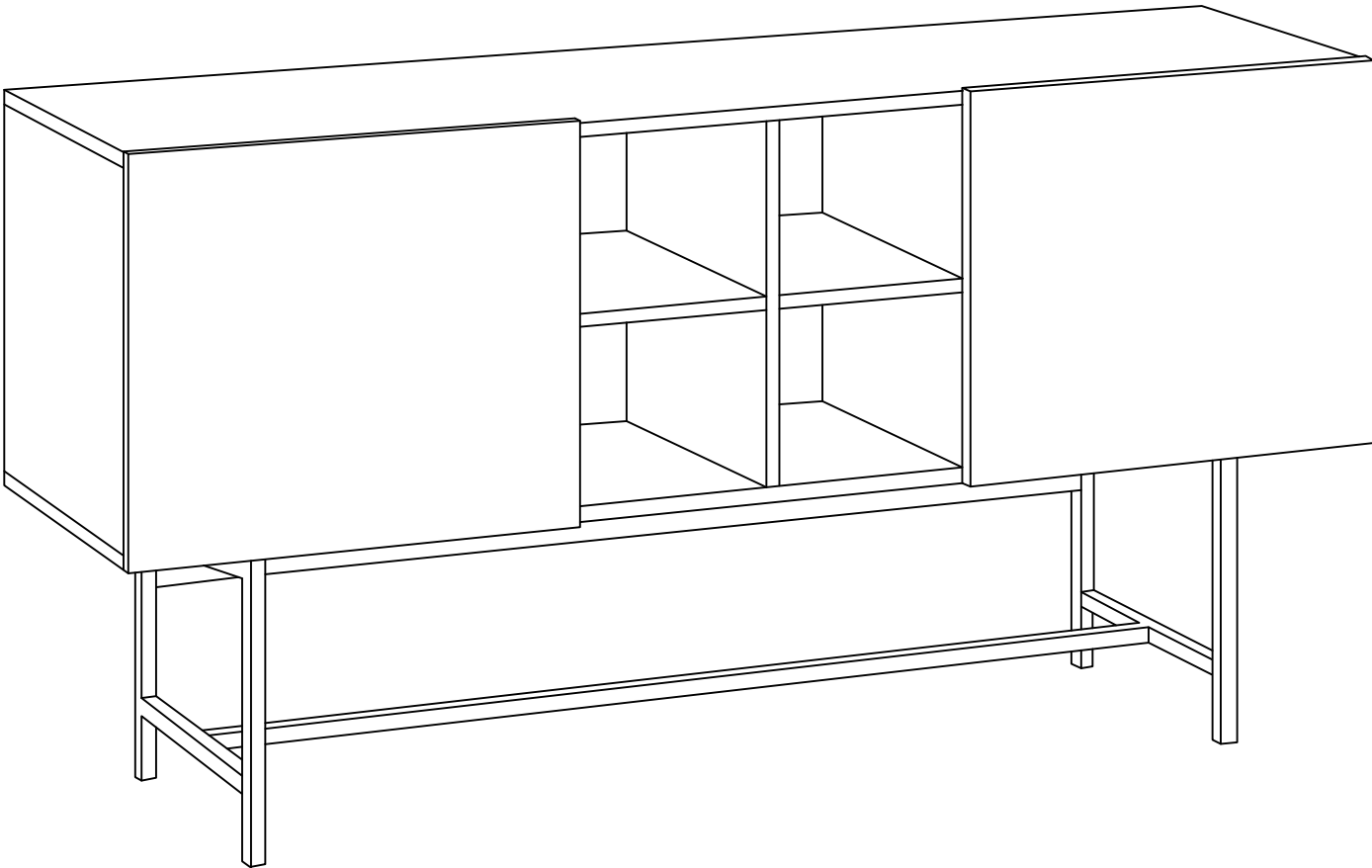

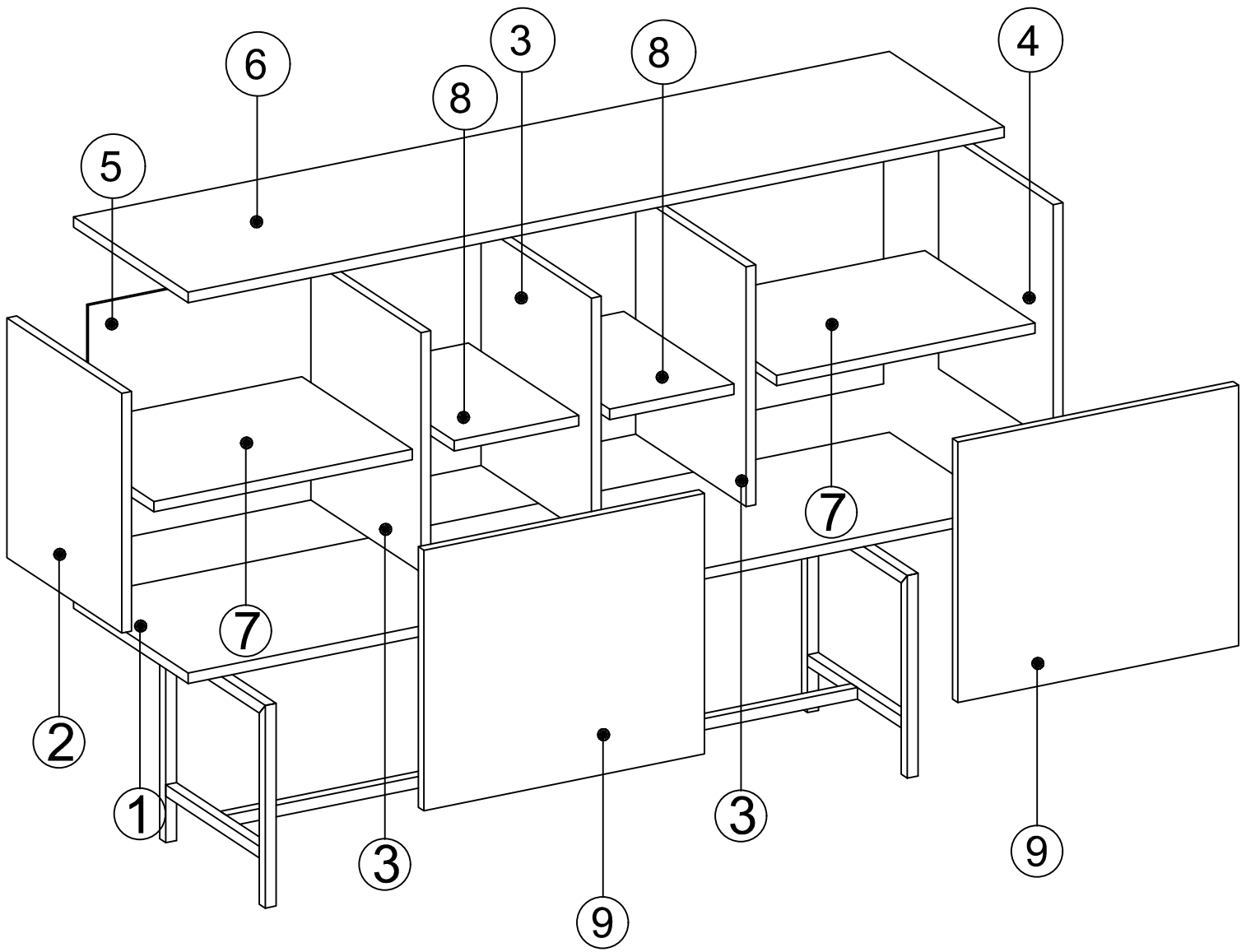

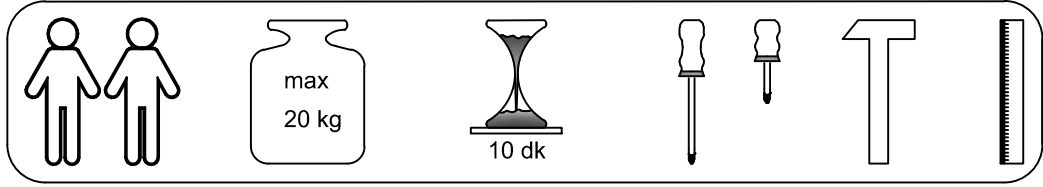





DEC20064 FLORY

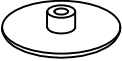

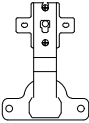

MATERIALS

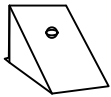
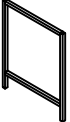

 X 20 A MINIFIX GIB	 X 20 B MINIFIX BODY	 X 20 C MIN.STOPPER	 X 20 D DOWEL
 X 22 G 3,5 x 18 SCREW	 X 8 N METRIC SCREW	 X 1 P ALLEN KEY	 X 4 S HINGE (Crank 0)
 X 16 AH SHELF BUTTON	 X 6 AJ PLASTIC JOINING	 X 2 AO METAL LEG AY35.35.02-Freya	 X 2 BE METAL LEG PART AT116.02.02

DEC20064 FLORY

NO	NAME	PIECE
1	BOTTOM PART	1 PC
2	LEFT PART	1 PC
3	MIDDLE PART	3 PCS
4	RIGHT PART	1 PC
5	BACK PART	1 PC
6	TOP PART	1 PC
7	SHELF	2 PCS
8	SHELF	2 PCS
9	COVER PARTS	2 PCS

NO	İSİM	ADET
1	ALT TABLA	1 ADET
2	SOL YAN	1 ADET
3	ORTA DİKME	3 ADET
4	SAĞ YAN	1 ADET
5	ARKALIK	1 ADET
6	ÜST TABLA	1 ADET
7	RAF	2 ADET
8	RAF	2 ADET
9	KAPAK	2 ADET

