

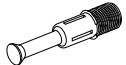





MATERIALS

 x28	 x28	 x28	 x38	 x26	 x4
B	A	C	D	AH	AJ
MINIFIX BODY	MINIFIX GIB	MIN.STOPPER	DOWEL	SHELF BUTTON	PLASTIC JOINING
 x2	 x2	 x 12	 x4	 x20	 x4
O	R	EV	U	I	BN
HANDLE SCREW	HANDLE	4x35 SCREW	HINGE (CRANK 16)	3,5x18 SCREW	250 mm PVC LEG

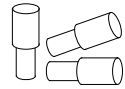
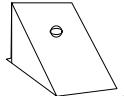
NO	DEC0034 REGULUS	PIECE
1	BOTTOM PART	1 PC
2	LEFT PART	1 PC
3	FIXED PART	1 PC
4	MIDDLE PART	1 PC
5	FIXED PART	1 PC
6	FIXED PART	1 PC
7	MIDDLE PART	1 PC
8	RIGHT SIDE PART	1 PC
9	TOP PART	1 PC
10	BACK PART	1 PC
11	COVER LEFT SIDE PART	1 PC
12	COVER RIGHT SIDE PART	1 PC
13	SHELF PARTS	3 PCS
14	SHELF PART	1 PC
15	SHELF PARTS	2 PCS

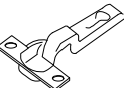
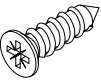
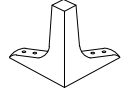
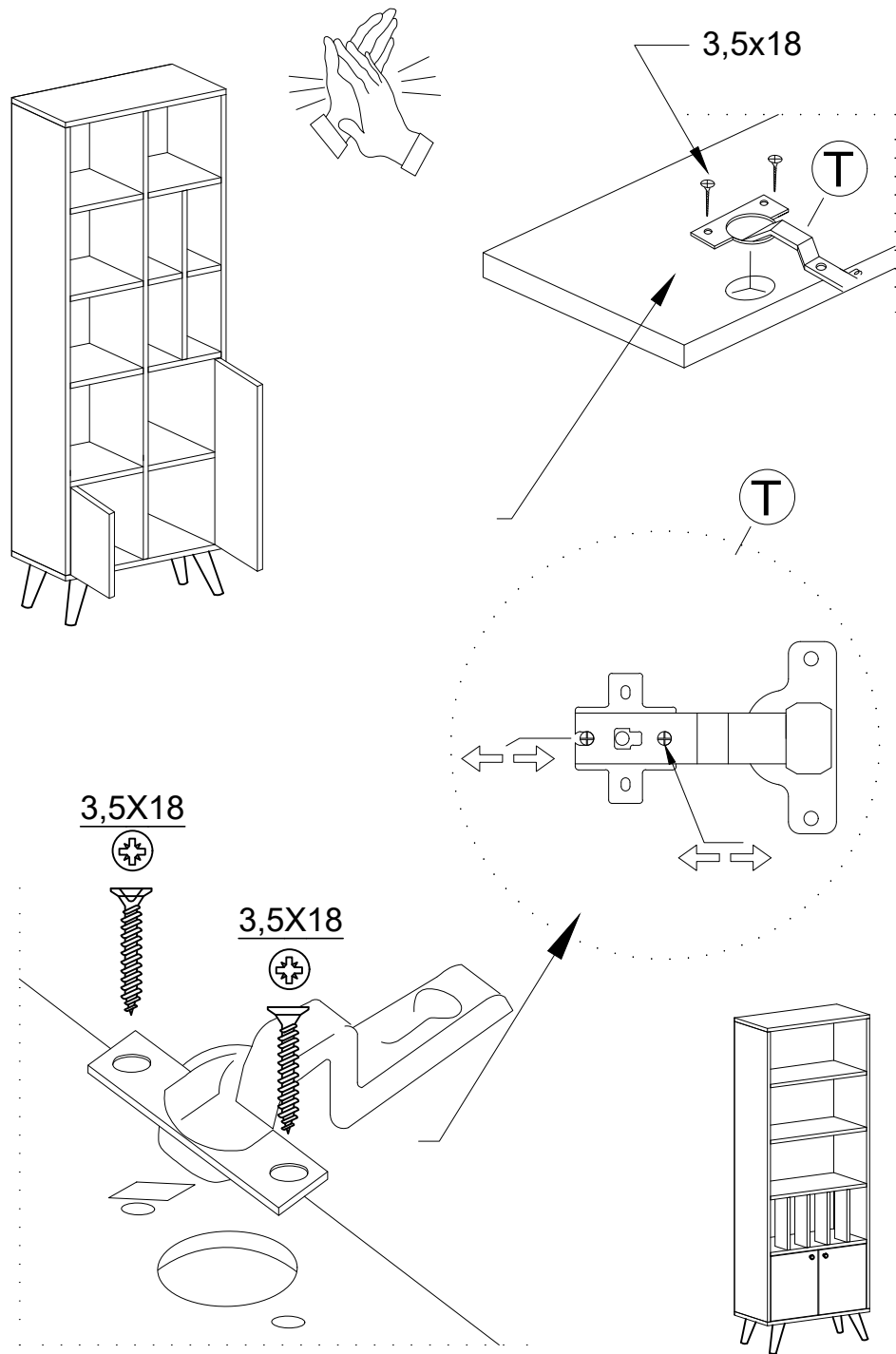

DEC0034 REGULUS

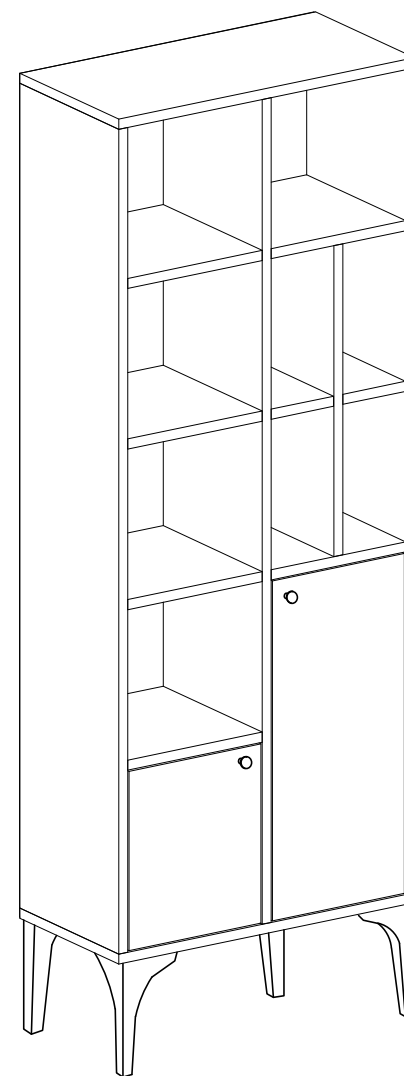

DECORMET