

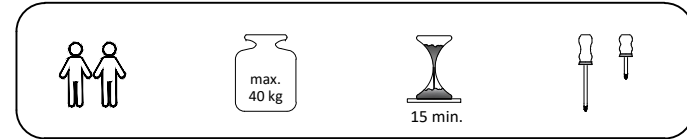

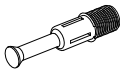







MATERIALS

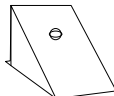

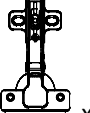
 x15	 x15	 x15	 x15	 x4	 x8
A	C	D	B	AJ	E
MINIFIX GIB	MIN.STOPPER	DOWEL	MINIFIX BODY	PLASTIC JOINING	CABINET SCREW
 x4	 x16	 x6	 x36	 x4	 x2
T	EY	U	I	BN	L / AK
HINGE (CRANK 7)	4x30 SCREW	HINGE (CRANK 16)	3,5x18 SCREW	170 mm PVC LEG	5x80 SCREW/WALL PLUG

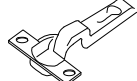
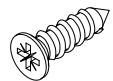
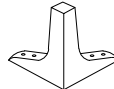
NO	DEC0045 CURSA	PIECE
1	TOP PART	1 PC
2	LEFT PART	1 PC
3	MIDDLE PART	1 PC
4	RIGHT PART	1 PC
5	BOTTOM PART	1 PC
6	BACK PART	1 PC
7	COVER PARTS	4 PCS
8	SHELF/ BACK PART	1 PC
9	SHELF/ BOTTOM PART	1 PC
10	SHELF /MIDDLE PART	4 PCS

DEC0045 CURSA

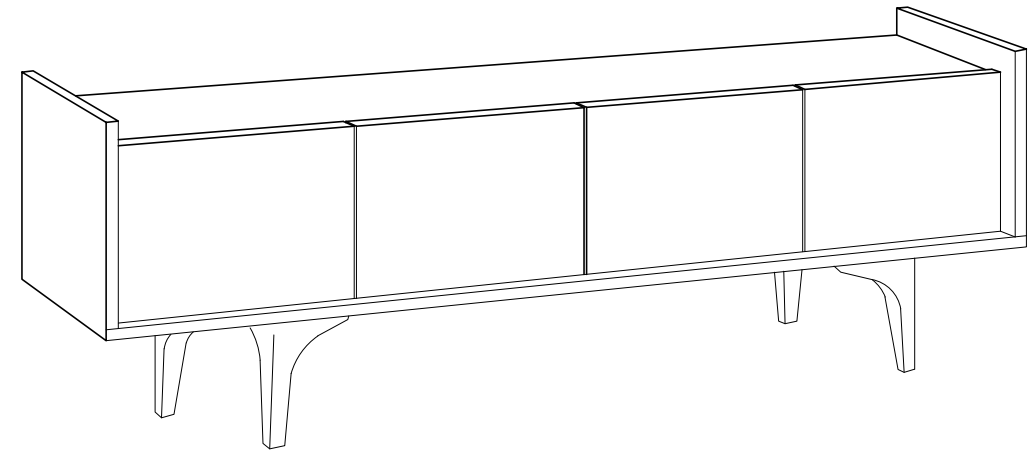
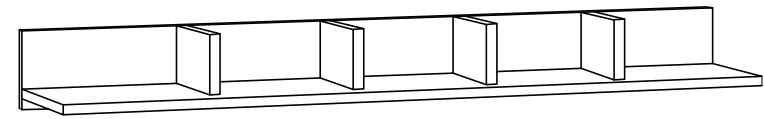
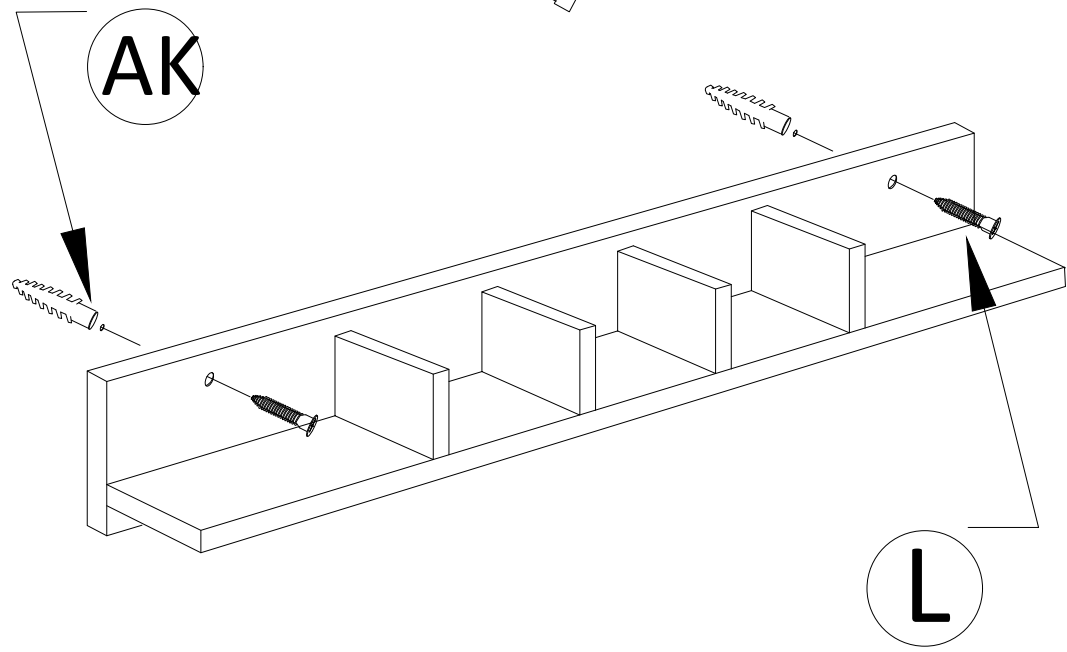

DECORMET