

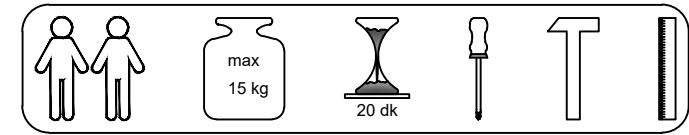











MATERIALS



					
X16	X16	X16	X16	X2	X12
A	B	C	D	U	G
MINIFIX GIB	MINIFIX BODY	MIN.STOPPER	DOWEL	HINGE(Crank 16)	3.5x18 SCREW
					
X1	X1	X10	x13	X4	X2
O	R	EU	AH	AJ	BZ
HANDLE SCREW	HANDLE	6 x 15 SCREW	SHELF BUTTON	PLASTIC JOINING	FOLDING TABLE PIECE

DEC0105-DEC0106

NO	NAME	PIECE	NO	İSİM	MİKTAR
1	BOTTOM PART	1 PC	1	ALT TABLA	1 Adet
2	LEFT SIDE PART	1 PC	2	SOL YAN DİKME	1 Adet
3	BACK PART	1 PC	3	ARKALIK	1 Adet
4	MIDDLE PART	1 PC	4	ORTA TABLA	1 Adet
5	RIGHT SIDE PART	1 PC	5	SAĞ YAN DİKME	1 Adet
6	MIDDLE PART	1 PC	6	ORTA DİKME	1 Adet
7	TOP PART	1 PC	7	ÜST TABLA	1 Adet
8	SHELF	1 PC	8	HAREKETLİ RAF	1 Adet
9	SHELF	2 PCS	9	HAREKETLİ RAF	2 Adet
10	TABLE PANEL	1 PC	10	MASA TABLASI	1 Adet
11	COVER	1 PC	11	KAPAK	1 Adet

DEC0105-DEC0106

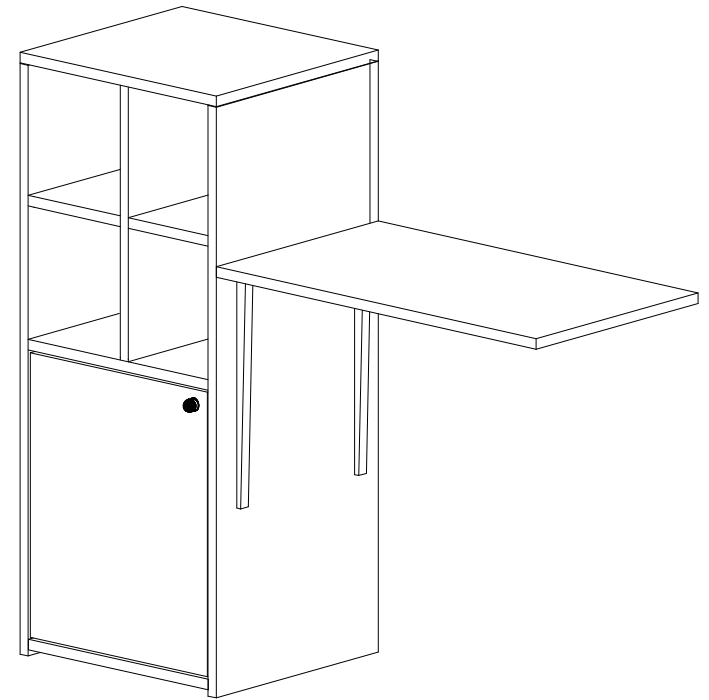
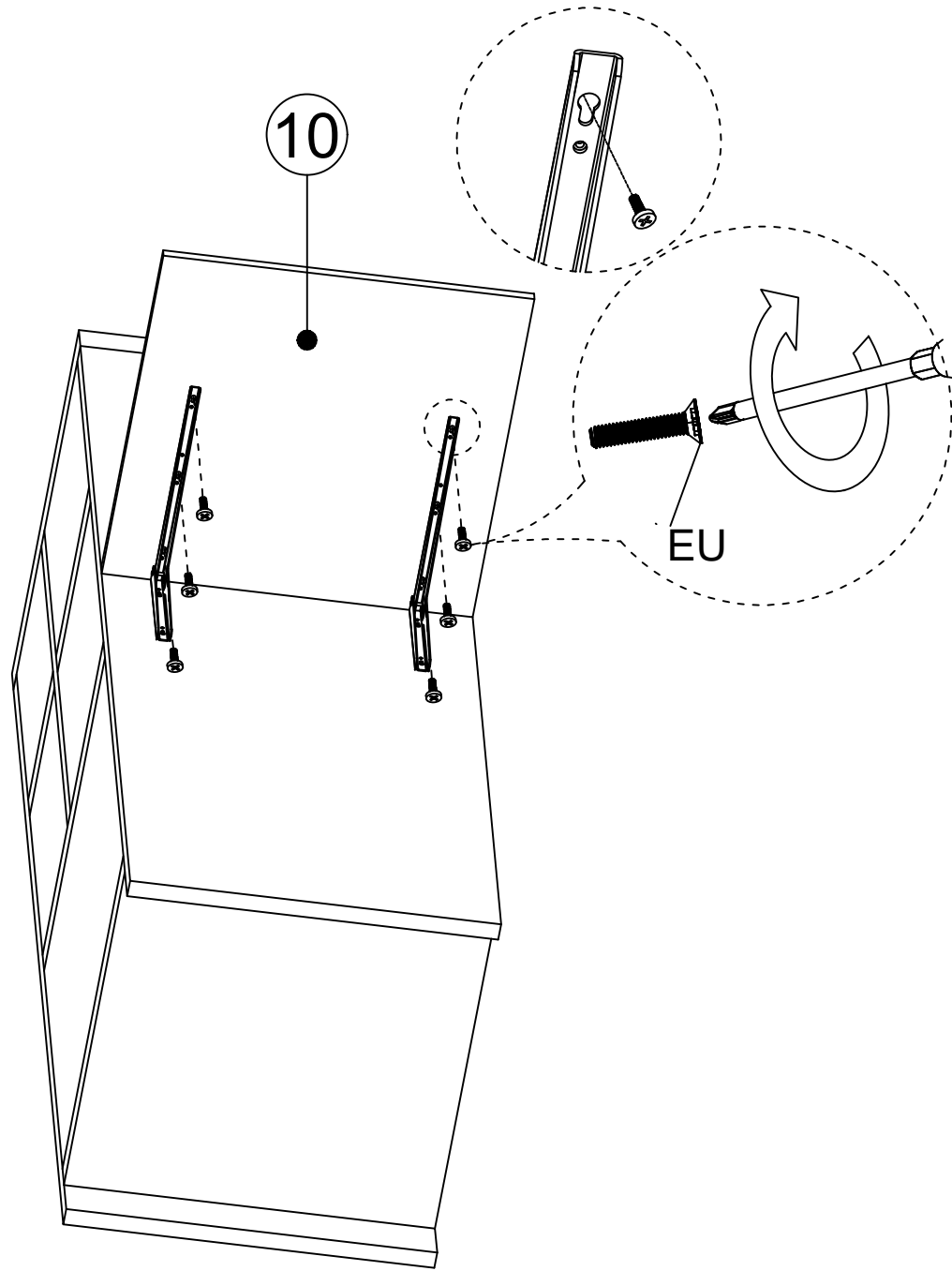

DECORMET