

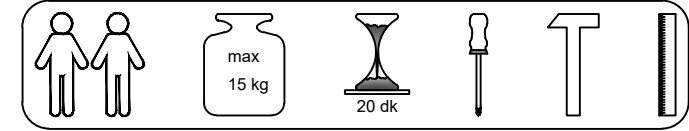











MATERIALS

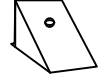

					
X16	X16	X16	X16	X 2	X 12
A	B	C	D	U	G
MINIFIX GIB	MINIFIX BODY	MIN.STOPPER	DOWEL	HINGE(Crank 16)	3.5x18 SCREW
					
X 1	X1	X10	X 5	X 4	X 2
O	R	EU	AH	AJ	BZ
HANDLE SCREW	HANDLE	6 x 15 SCREW	SHELF BUTTON	PLASTIC JOINING	FOLDING TABLE PIECE

DEC0107-DEC0108

NO	NAME	PIECE	NO	İSİM	MİKTAR
1	BOTTOM PART	1 PC	1	ALT TABLA	1 Adet
2	LEFT SIDE PART	1 PC	2	SOL YAN DİKME	1 Adet
3	BACK PART	1 PC	3	ARKALIK	1 Adet
4	MIDDLE PART	1 PC	4	ORTA TABLA	1 Adet
5	TOP PART	1 PC	5	ÜST TABLA	1 Adet
6	BACK PANEL	1 PC	6	ARKA PANEL	1 Adet
7	RIGHT SIDE PART	1 PC	7	SAĞ YAN DİKME	1 Adet
8	MIDDLE PART	2 PCS	8	DİKME	2 Adet
9	SHELF	1 PC	9	HAREKETLİ RAF	1 Adet
10	COVER	1 PC	10	KAPAK	1 Adet
11	TABLE PANEL	1 PC	11	MASA TABLASI	1 Adet

DEC0107-DEC0108

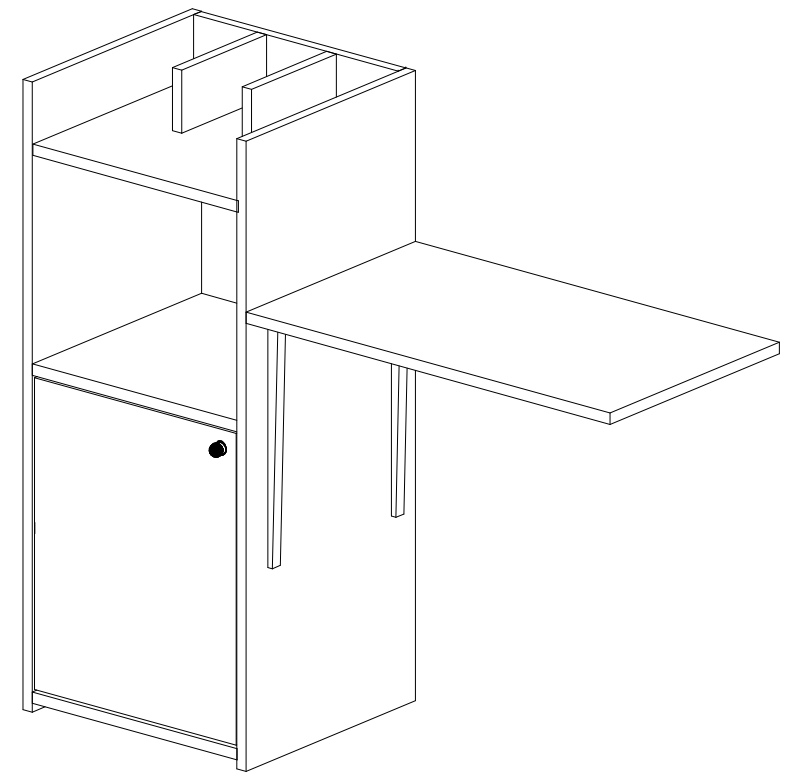
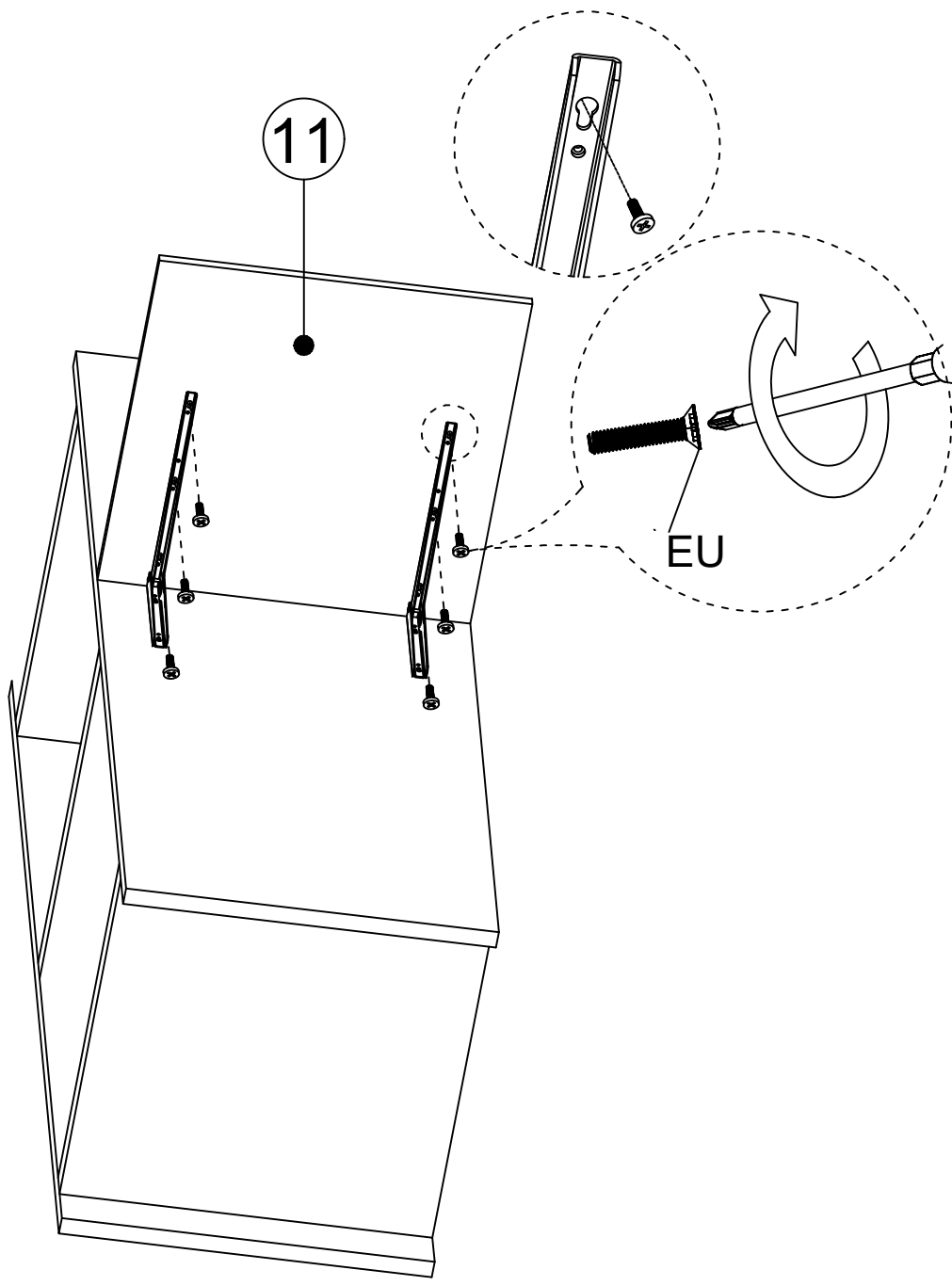

DECORMET