

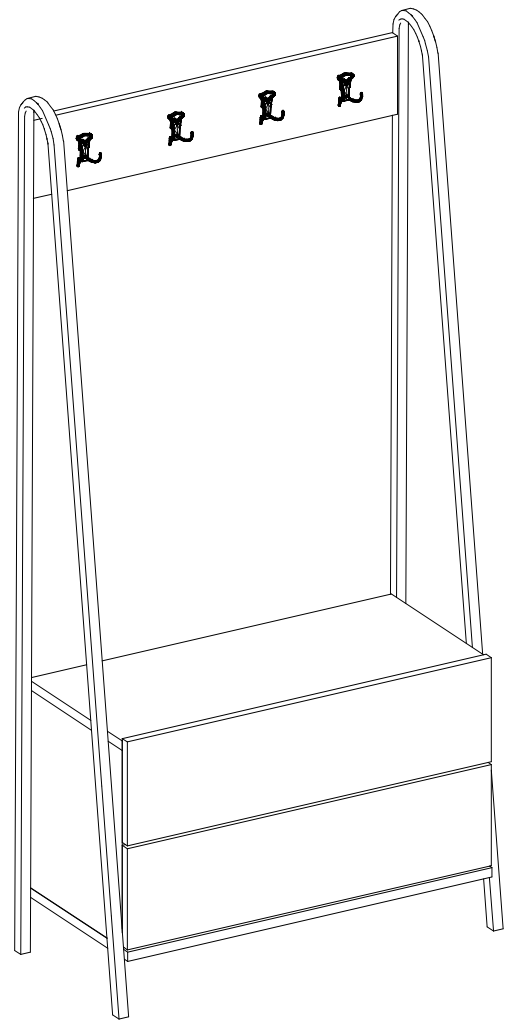

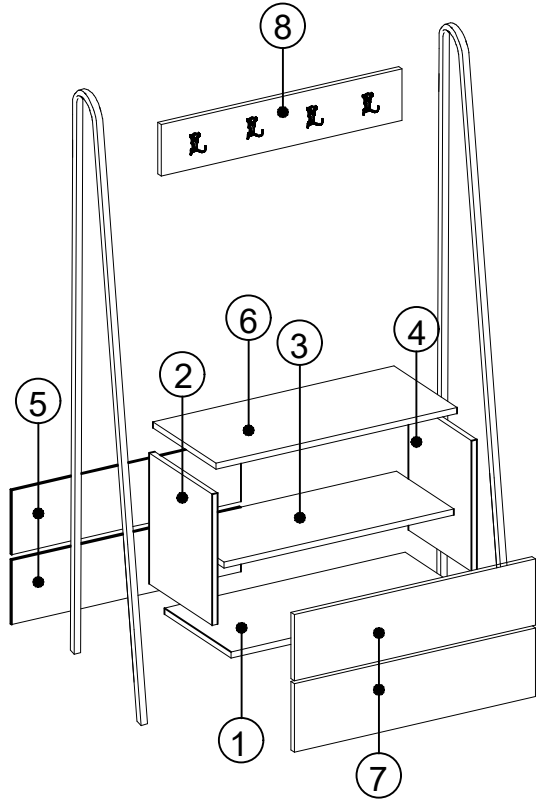

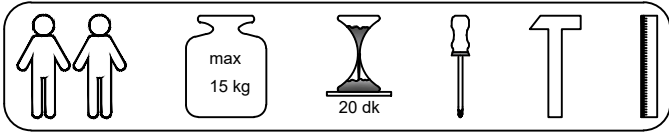







DEC0092



DECORMET

MATERIALS



		
X 12	X 12	X 12
A	B	C
MINIFIX GIB	MINIFIX BODY	MIN.STOPPER
		
X 12	X 2	X 2
D	S	U
DOWEL	HINGE (Crank 0)	HINGE(Crank 16)
		
X 28	X 4	X 4
G	AJ	AG
3,5x18 SCREW	PLASTIC JOINING	HANGING
		
X 12	X 1	
N	P	
METRIC SCREW	ALLEN KEY	

DEC0092			
NO	NAME	PIECE	
1	BOTTOM PART	1 PC	
2	LEFT SIDE PART	1 PC	
3	MIDDLE PART	1 PC	
4	RIGHT SIDE PART	1 PC	
5	BACK PART	2 PCS	
6	TOP PART	1 PC	
7	COVER	2 PCS	
8	HANGER PANEL	1 PC	
NO	İSİM	MIKTAR	
1	ALT TABLA	1 Adet	
2	SOL YAN DİKME	1 Adet	
3	ORTA TABLA	1 Adet	
4	SAĞ YAN DİKME	1 Adet	
5	ARKALIK	2 Adet	
6	ÜST TABLA	1 Adet	
7	KAPAK	2 Adet	
8	ASKI PANOSU	1 Adet	

