

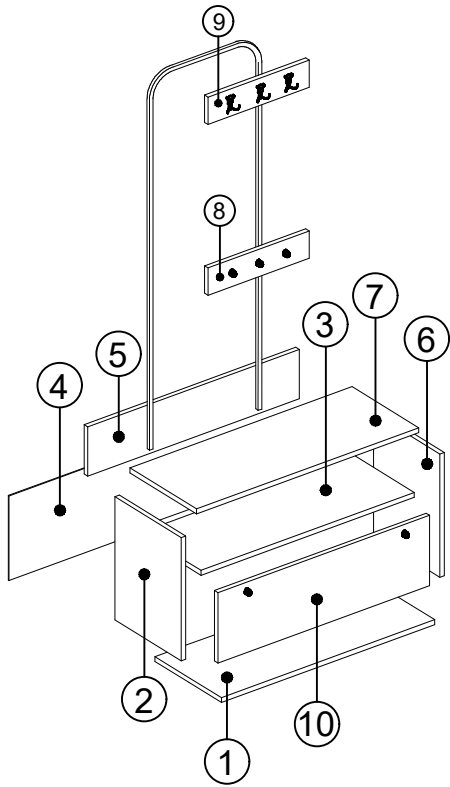

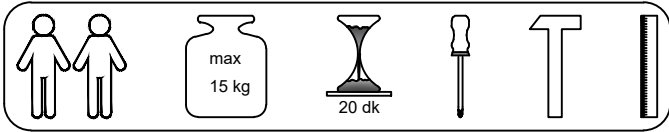







MATERIALS

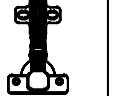

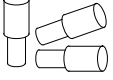
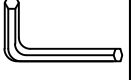
		
X 14	X 14	X 14
A	B	C
MINIFIX GIB	MINIFIX BODY	MIN.STOPPER
		
X 14	X 2	X 14
D	U	G
DOWEL	HINGE(Crank 16)	3,5x18 SCREW
		
X 1	X 1	X 3
AH	P	AG
SHELF BUTTON	ALLEN KEY	HANGING
		
X 10	X 5	X 5
N	O	R
METRIC SCREW	HANDLE SCREW	HANDLE

DEC0096 - DEC0097					
NO	NAME	PIECE	NO	İSİM	MİKTAR
1	BOTTOM PART	1 PC	1	ALT TABLA	1 Adet
2	LEFT SIDE PART	1 PC	2	SOL YAN DİKME	1 Adet
3	MIDDLE PART	1 PC	3	ORTA TABLA	1 Adet
4	BACK PART	1 PC	4	ARKALIK	1 Adet
5	BACK PANO	1 PC	5	ARKA PANO	1 Adet
6	RIGHT SIDE PART	1 PC	6	SAĞ YAN DİKME	1 Adet
7	TOP PART	1 PC	7	ÜST TABLA	1 Adet
8	HANGER PANEL	1 PC	8	ASKI PANOSU	1 Adet
9	HANGER PANEL	1 PC	9	ASKI PANOSU	1 Adet
10	COVER	1 PC	10	KAPAK	1 Adet

