

# LORD DRESUAR KONSOL

---

INSTALLATION AND USER MANUAL

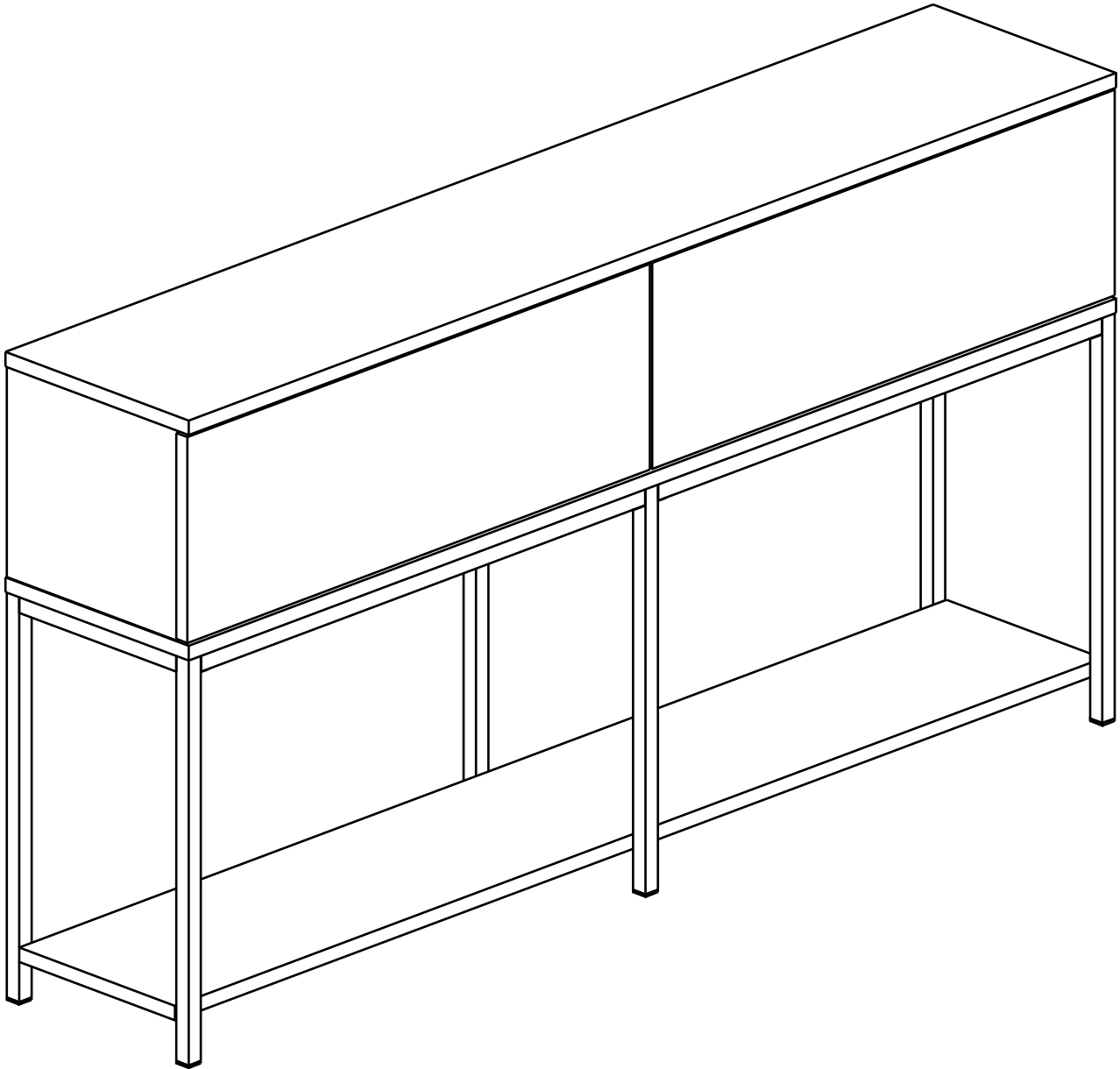

Dear Customer.

All products are manufactured from the design process to the scope of production and delivery.

At every step, it has been checked and tested to ensure the enjoyment it produces and its reliable use for many years.

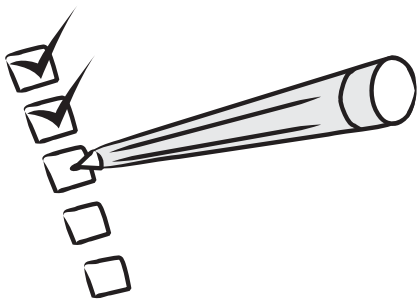

Before starting the assembly, take all the parts out of the box and check them according to the assembly manual. If you have purchased more than one product, install the products in order to avoid mixing parts and accessories.

Before starting the assembly, clean each part with a damp cloth. This cleaning will also be sufficient for general use of the product.







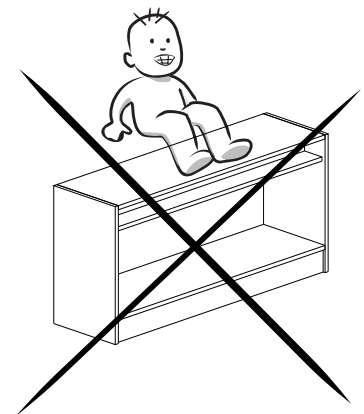

Do not use your furniture for purposes other than its intended purpose. Please contact us when considering different purposes of use.

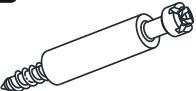
Furniture can be damaged when it comes into direct contact with cold, heat or moisture. Therefore, prevent your furniture from coming into direct contact with these factors.

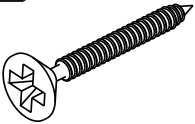
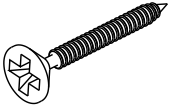
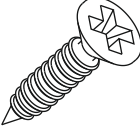

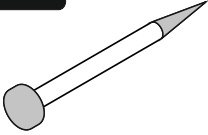
# ACCESSORY LIST

<b>A1</b> Minifix Miles  <b>6x</b>	<b>A2</b> Dowel  <b>4x</b>	<b>A3</b> Minifix Body k18  <b>6x</b>	<b>A4</b> 4x70 Screw  <b>6x</b>
<b>A5</b> 4x35 Screw  <b>5x</b>	<b>A6</b> 3x18 Screw  <b>23x</b>	<b>A7</b> 3x25 Screw  <b>3x</b>	<b>A8</b> Backrest Nail  <b>20x</b>
<b>A9</b> Super Hinge  <b>4x</b>			

