

INSTALLATION GUIDE

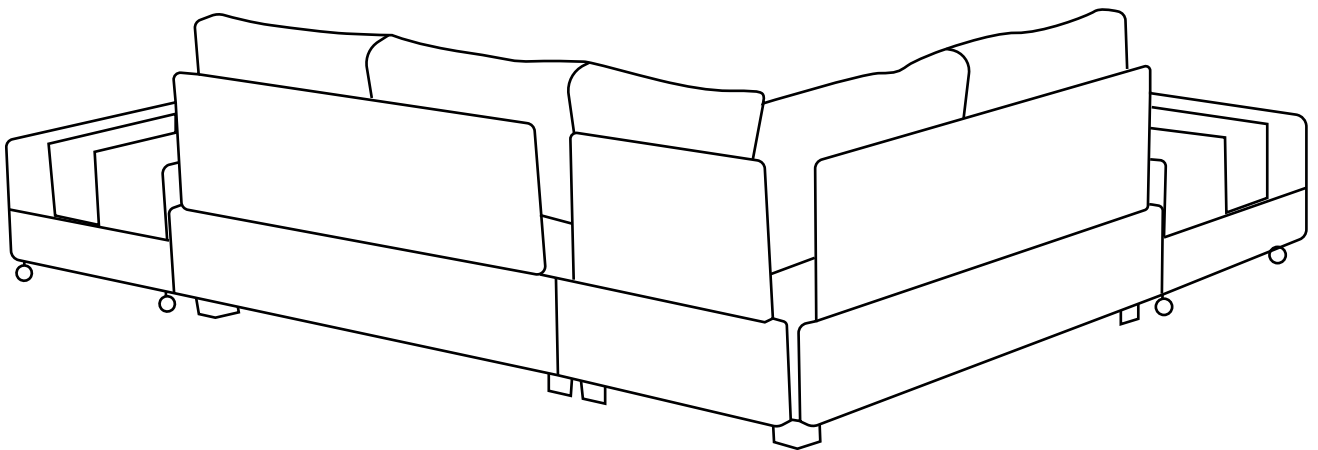

Read these assembly instructions carefully before you start.

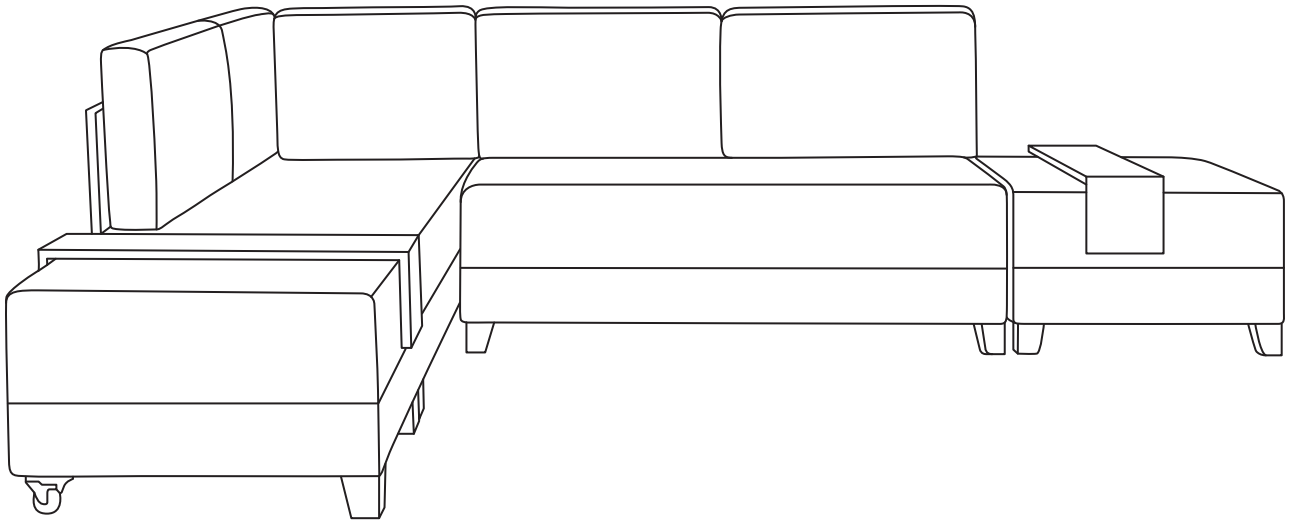

Two people are required to assemble and transport the sofa.



Safety first! Do not allow children to handle or play with the furniture.



A mild upholstery cleaner spray or a mixture of warm water to clean fabric sofas. For leather sofas, it is recommended to clean with a leather cleaner and softener spray. It is important to use cleaning products that are suitable for this sofa, and following the manufacturer's instructions will help ensure a long life for the product.

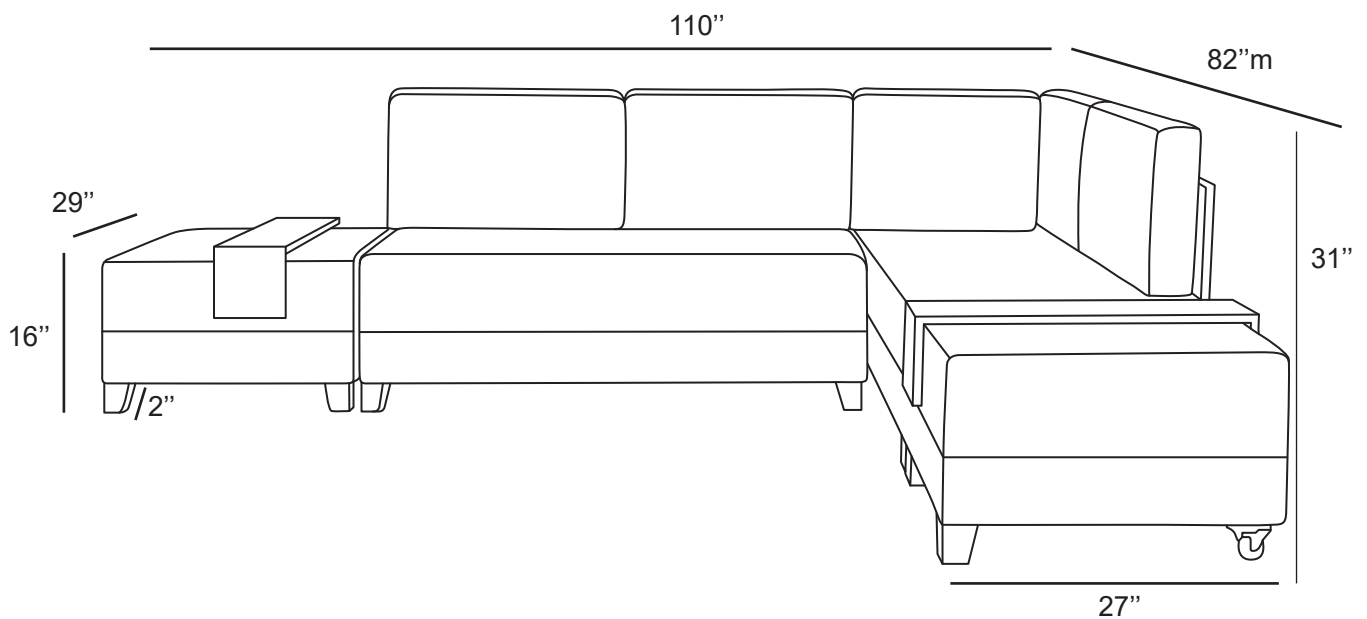

A

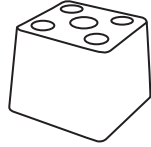

Plastic Foot
12 pcs

B

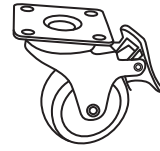

Wheel with Stop
4 pcs

C



4x35 Screw
28 pcs

D



5x50 Screw
48 pcs

E

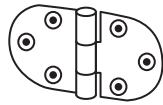

Pufa Mounted Hinge
2 pcs

F

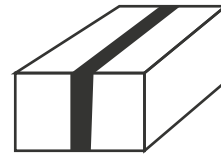

Arm stand box
1 piece

G



(Not included.)

H



(Not included.)

