

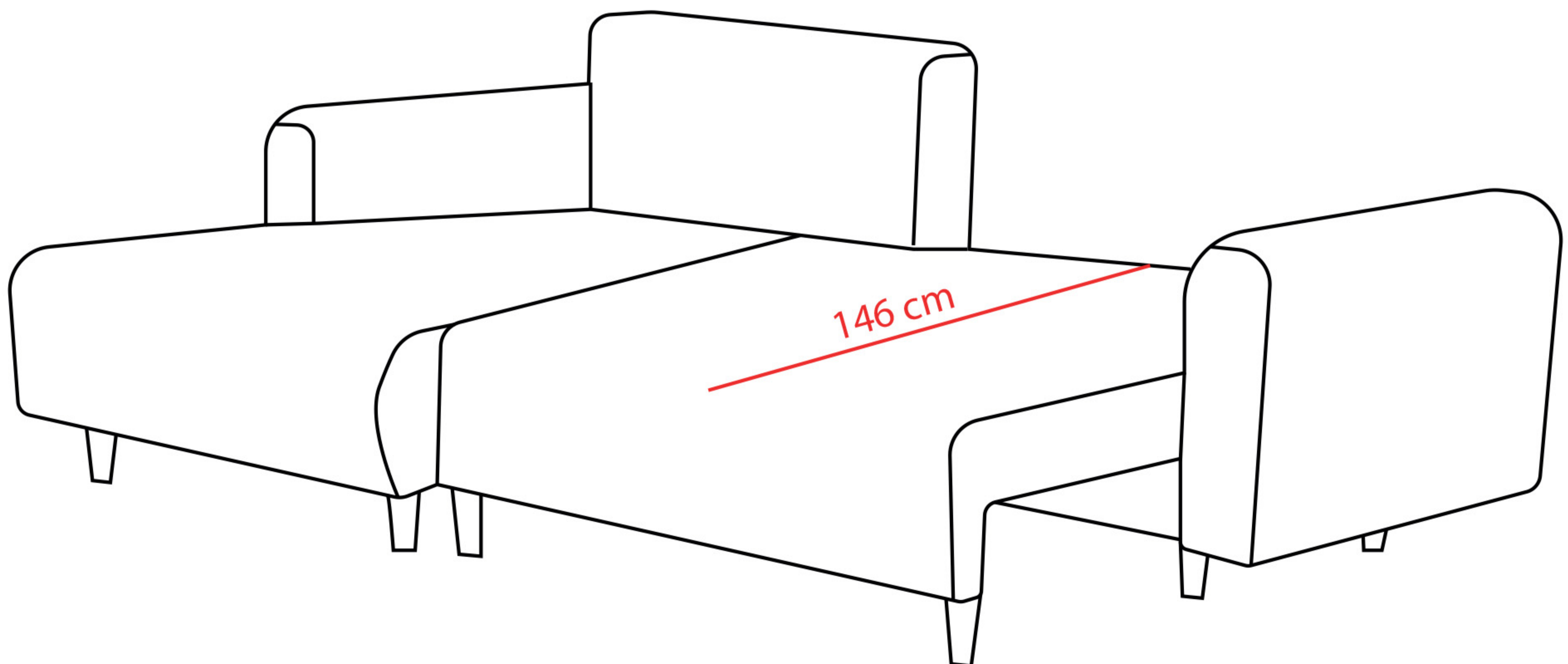

# ASSEMBLY GUIDE

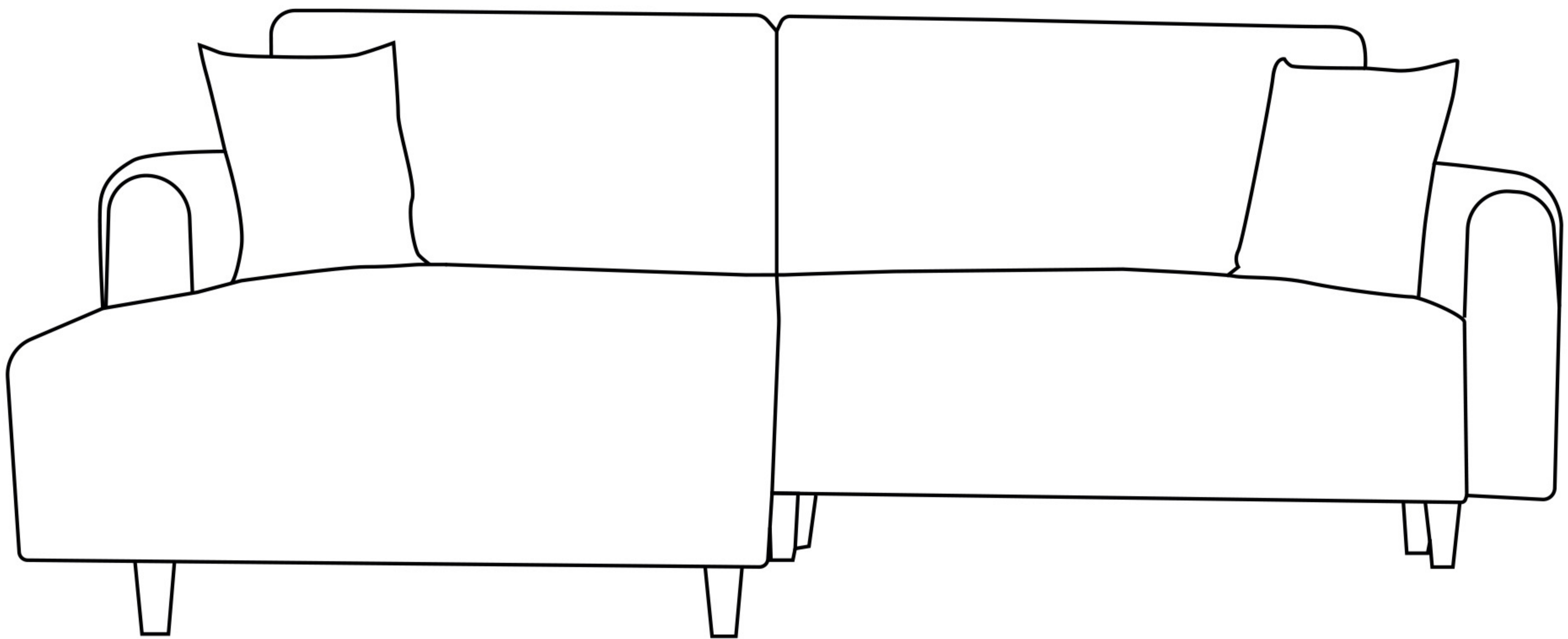



Before starting, carefully read these assembly instructions.

 Assembly and transportation of the sofa require two people.

 Safety first! Do not allow children to hold or play with the furniture.

 To clean fabric sofas, a mild upholstery cleaner spray or a mixture of warm soapy water is required. For leather sofas, it is recommended to:  
\* Use leather cleaner and conditioner.  
Suede sofas are cleaned with a suede brush or suede cleaner spray. It is important to use appropriate cleaning products for this sofa, and following the manufacturer's instructions will help you prolong its lifespan.

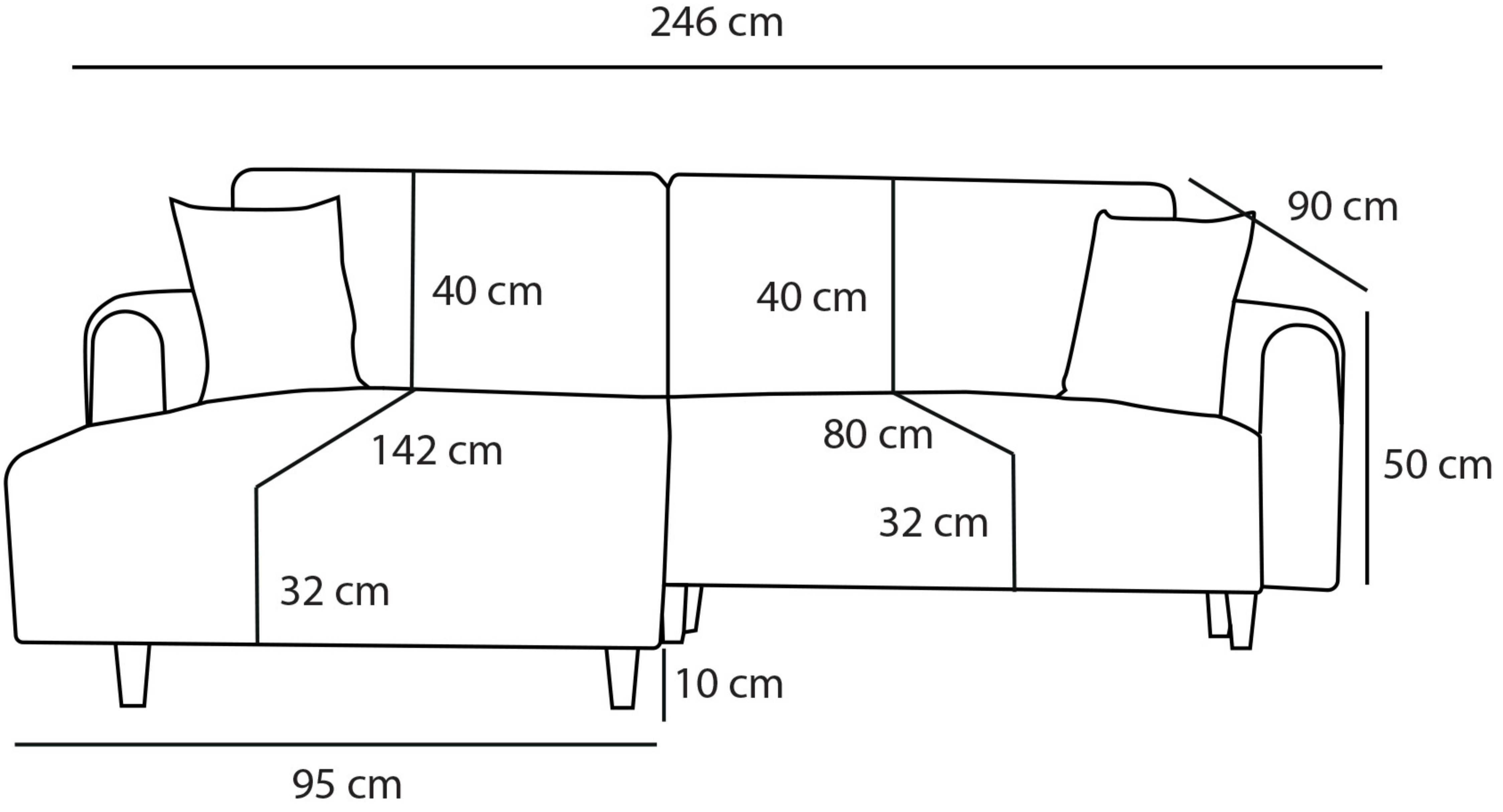



**A**



Screw-on Leg  
11 Pieces

**B**

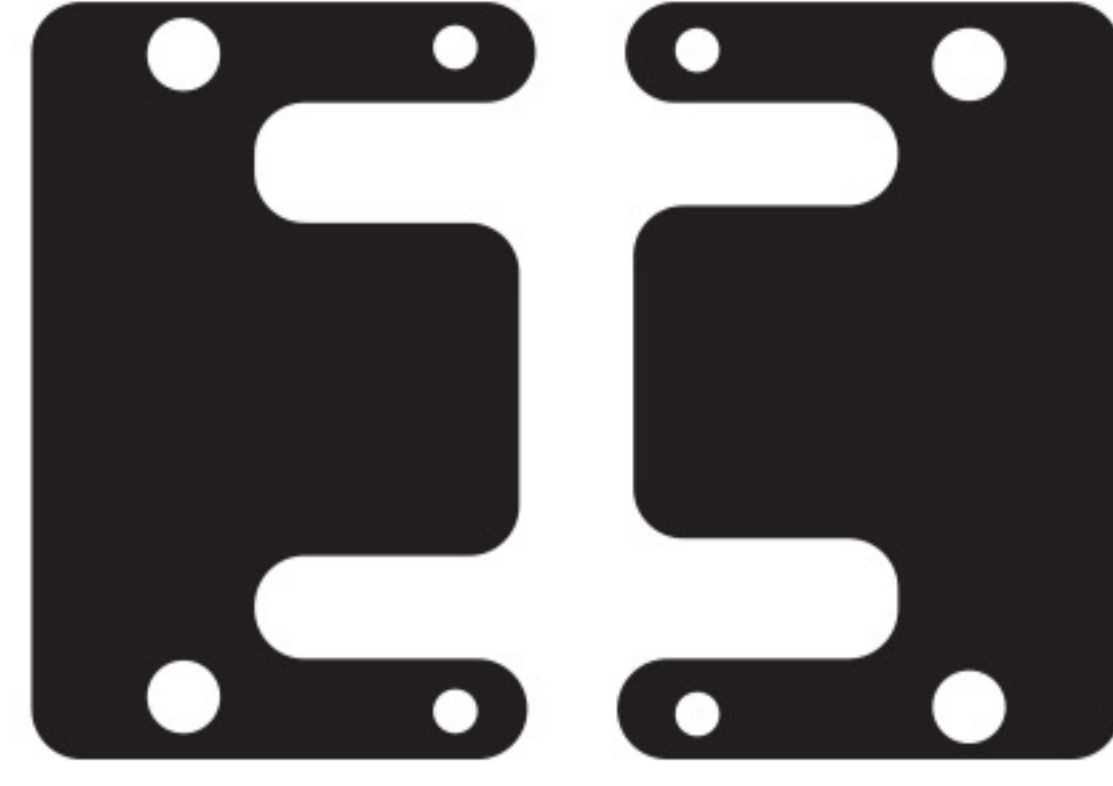

4 Pieces of Interlocking  
Connectors

**C**

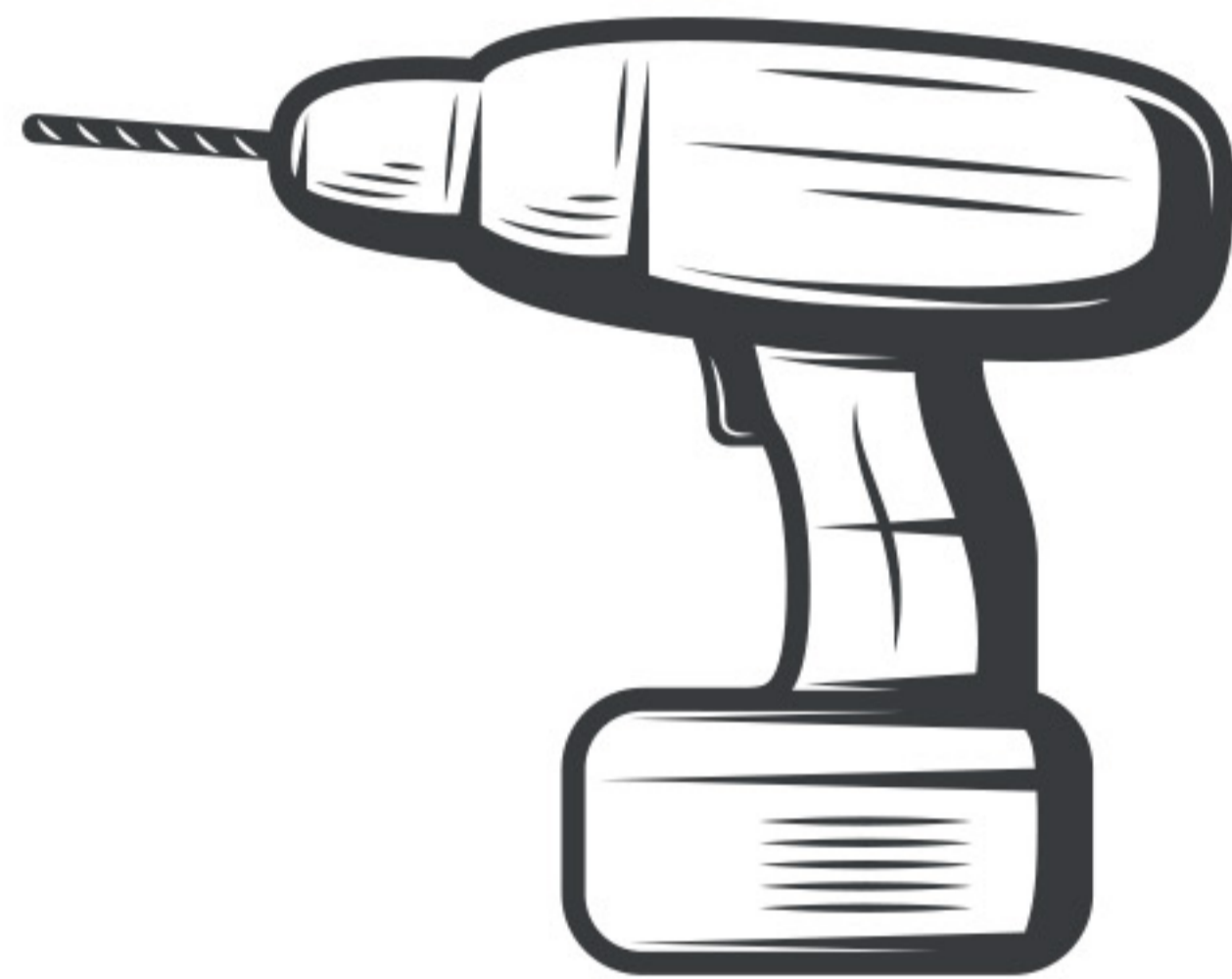

It is not included.

**D**



It is not included.

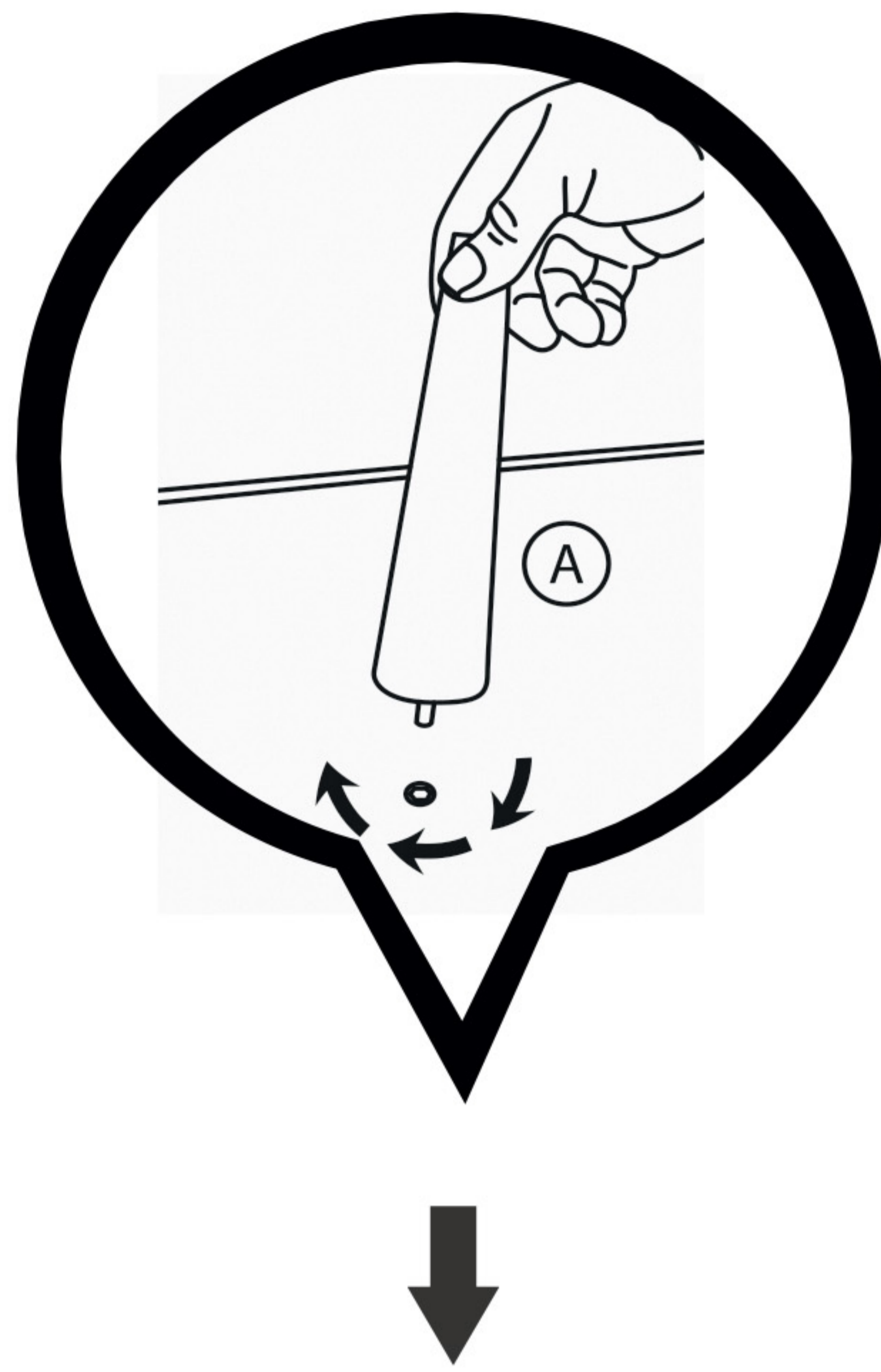

The product uses 11 legs. The legs are self-tapping, and you can complete the assembly by twisting them on.

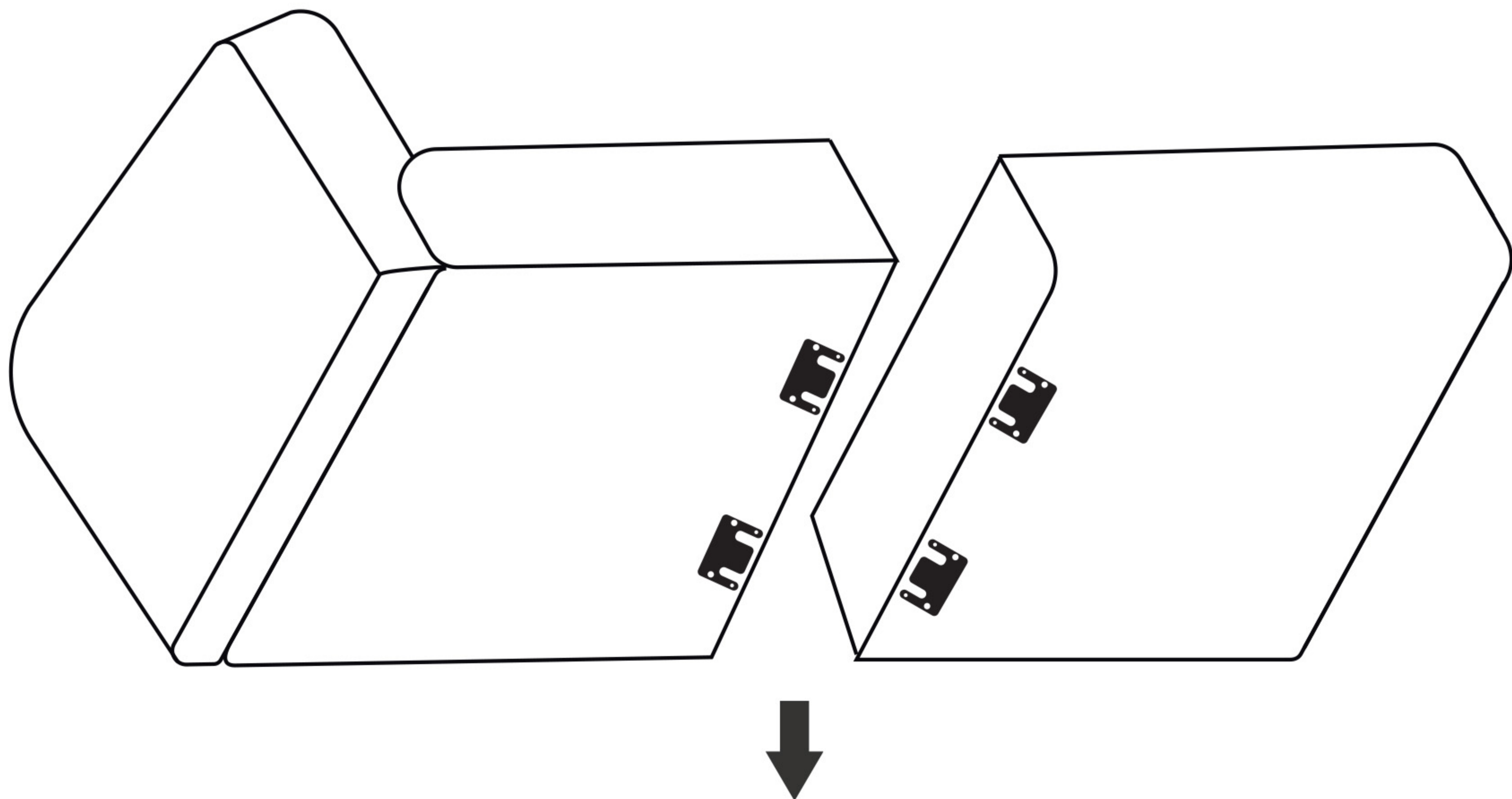

The product includes 4 interlocking connectors. You can connect these connectors together to complete the assembly.



