

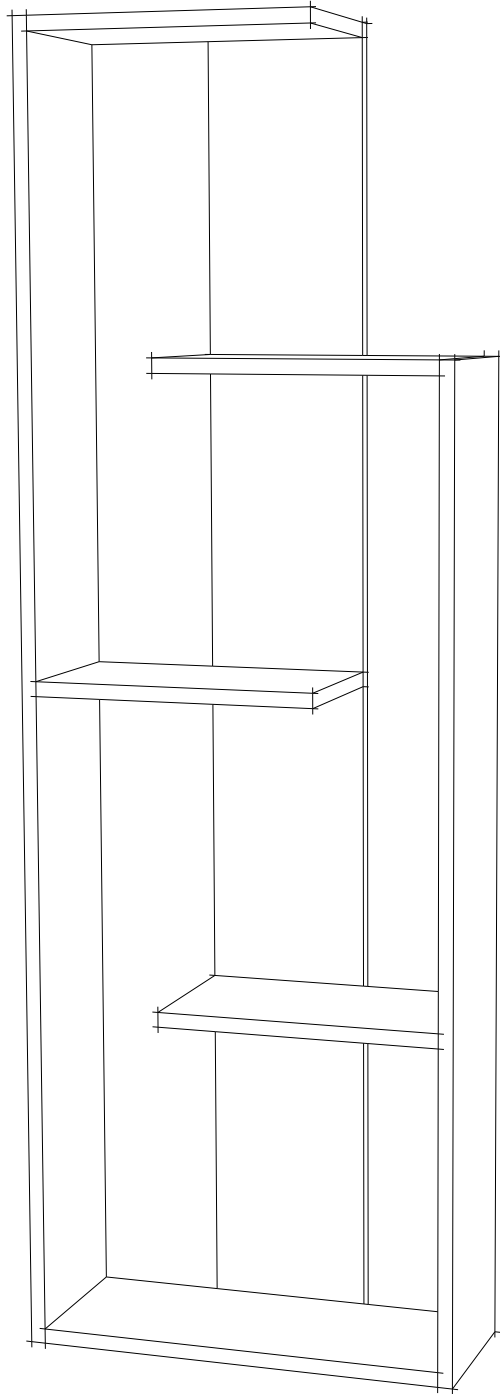

WAND KİTAPLIK

MONTAJ VE KULLANIM KLAVUZU
ASSEMBLY MANUEL





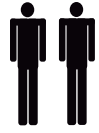

Bu modül iki kişi tarafından kurulmalıdır.
This unit should be assembled by two persons.

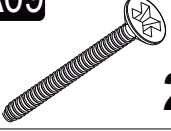

Bu modülün kurulumu için gerekli olan araçlar.
The necessary tools (not included)

AKSESUAR LİSTESİ/ ACCESSORY LIST

A09 4x50 YHB Vida  22x	A16 Kabin VidasıTapa  22x
--	---

PARÇA KODLAMA / GENERAL VIEW

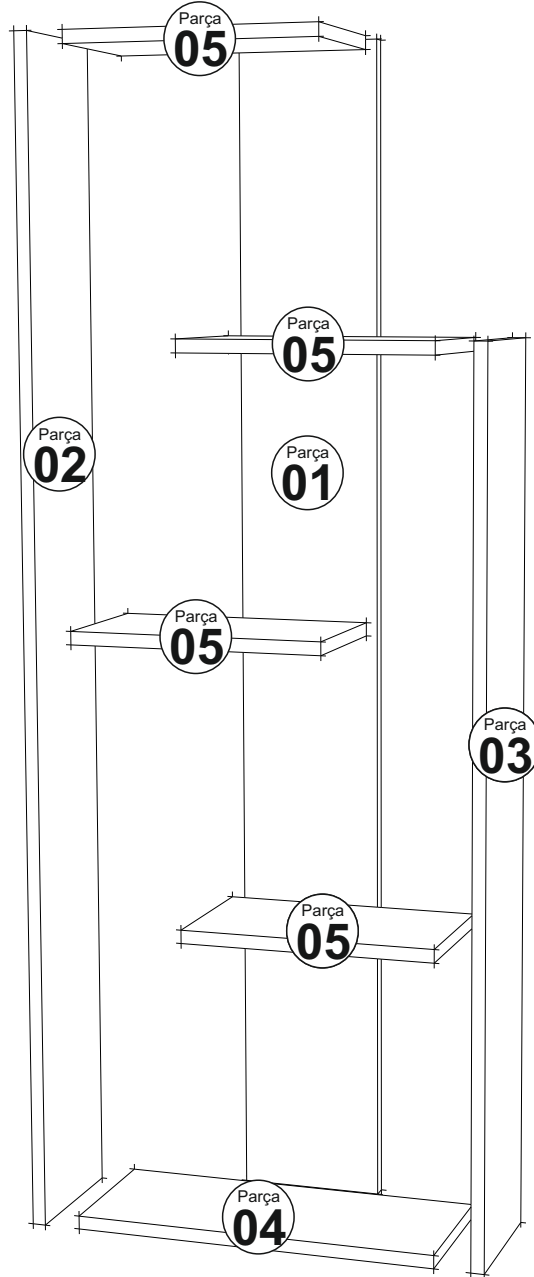

MONTAJKILAVUZU /ASSEMBLYMANUEL

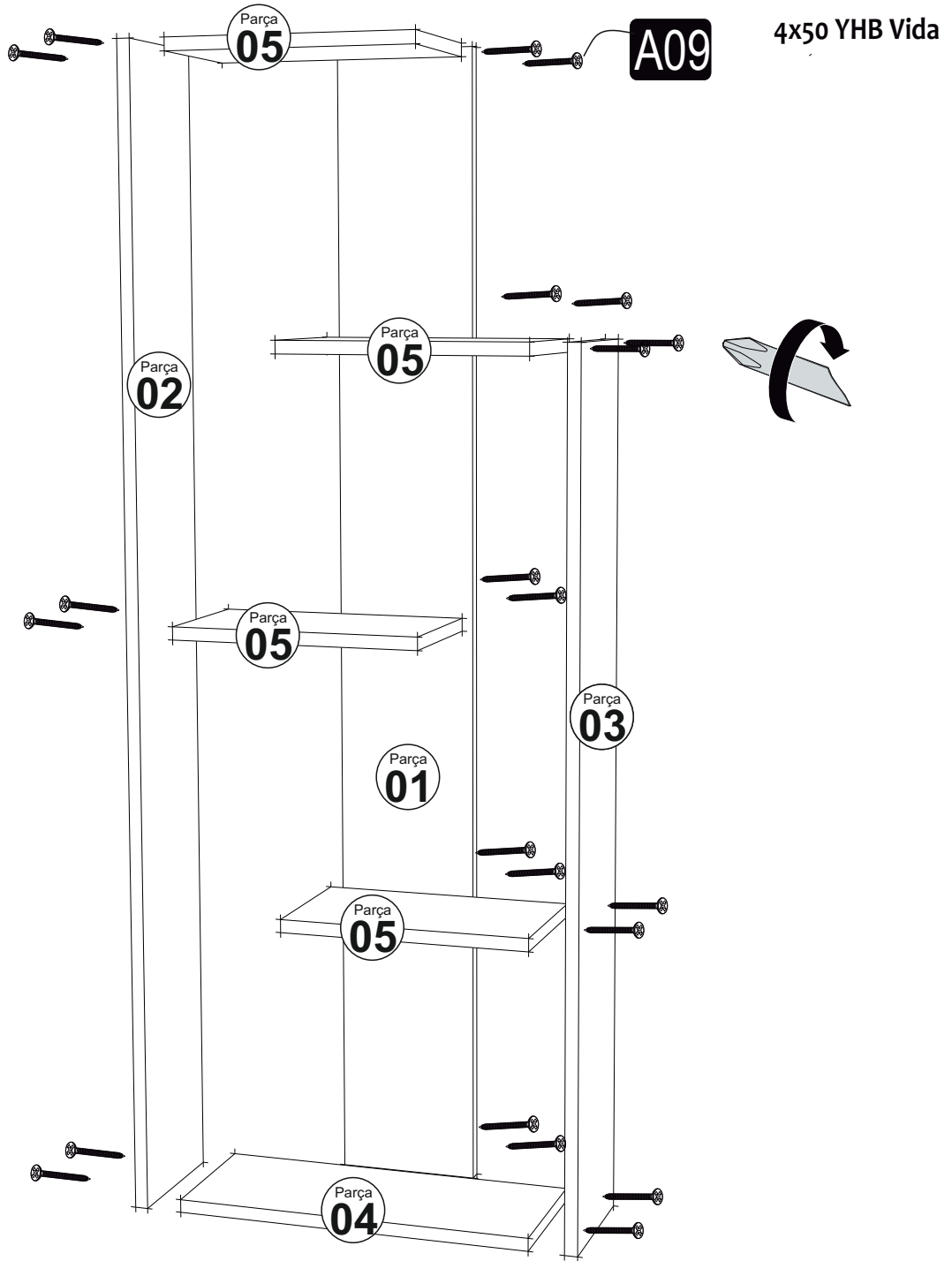

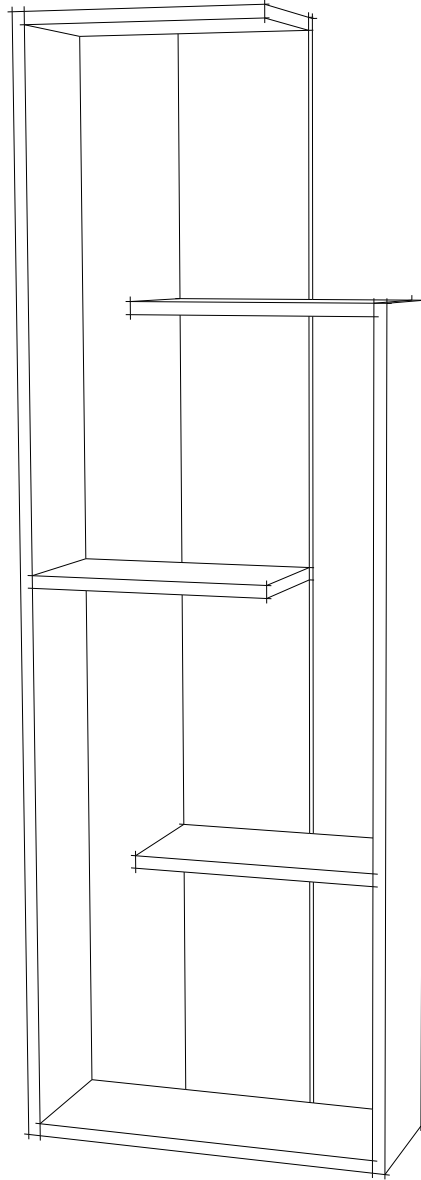

*D?đer ürünler?m?z? gördünüz mü?
Have you seen our other products ?*