

COSMO MATRIX KONSOL KURULUM ŐEMASI

ASSEMBLY GUIDE

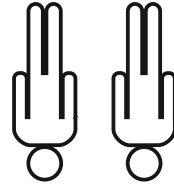



Bu modül iki kişi tarafından kurulmalıdır.

This unit should be assembled by two persons.

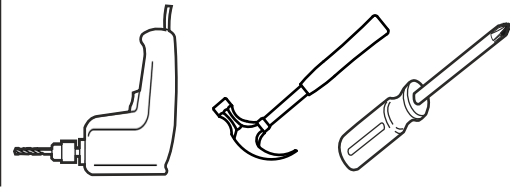

/ Bu modülün kurulumu için gerekli olan araçlar

The necessary tools (not included)

AKSESUAR LİSTESİ / ACCESSORY LIST

* AKSESUARLARI GÖSTERİLDİĞİ GİBİ DÜZ BİR ZEMİN ÜZERİNDE TAKINIZ...

* ÜRÜNÜ KURARKEN MONTAJ SIRASINI TAKİP EDİNİZ

* FİX THE ACCESSORIES AS SHOWN FOLLOW THE

INSTALLATION SEQUENCE WHILE INSTALLING THE PRODUCT.

1

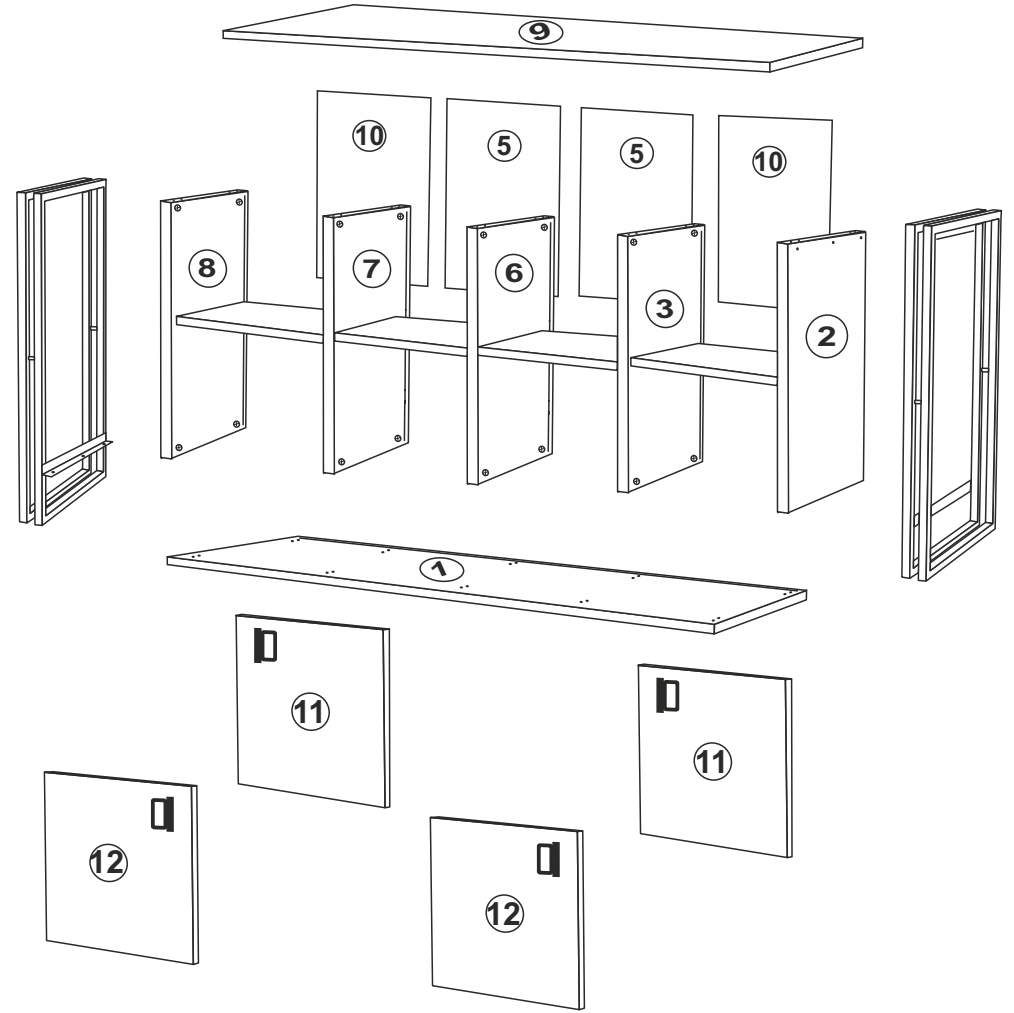
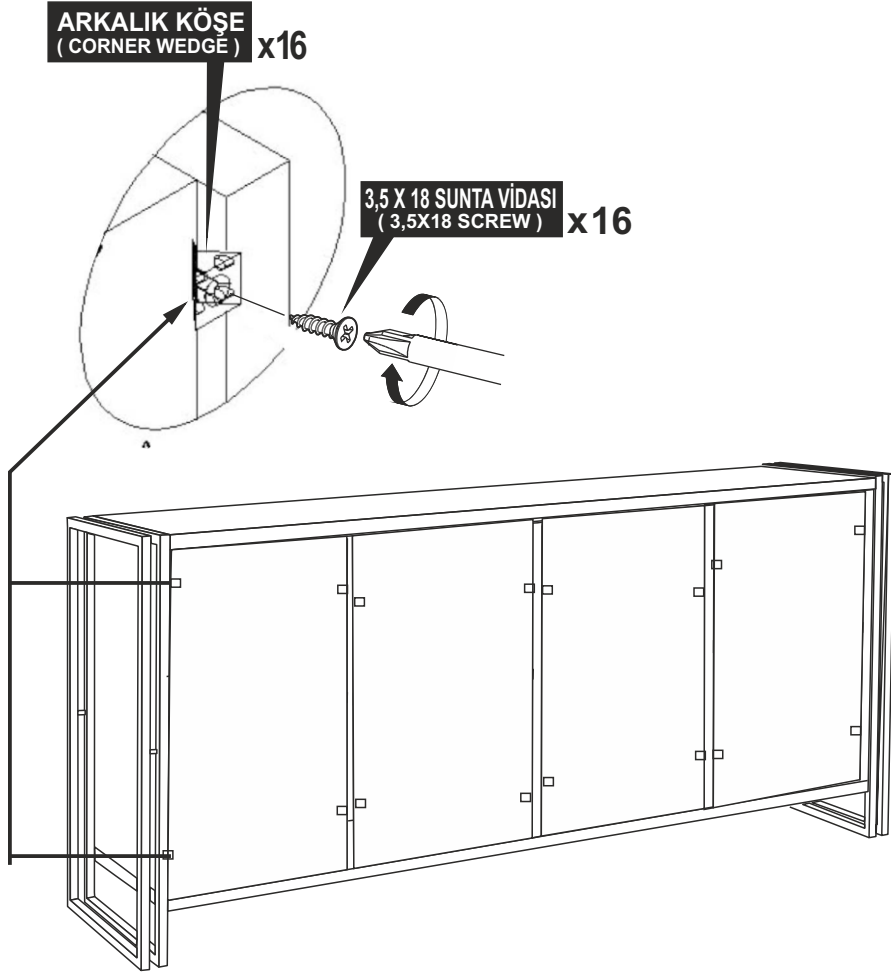

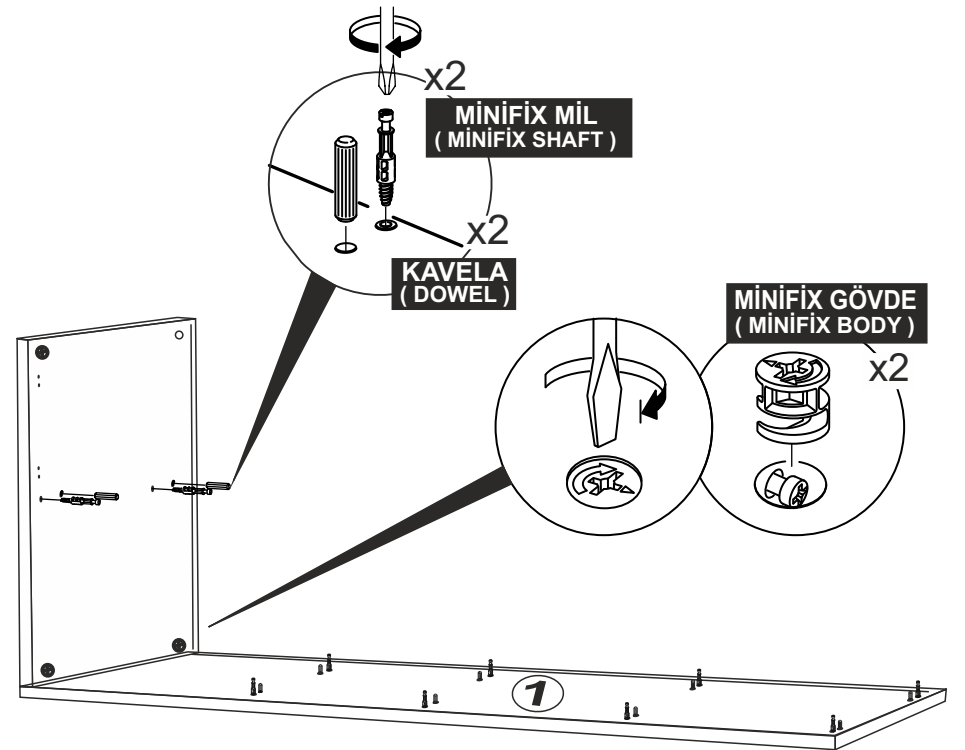
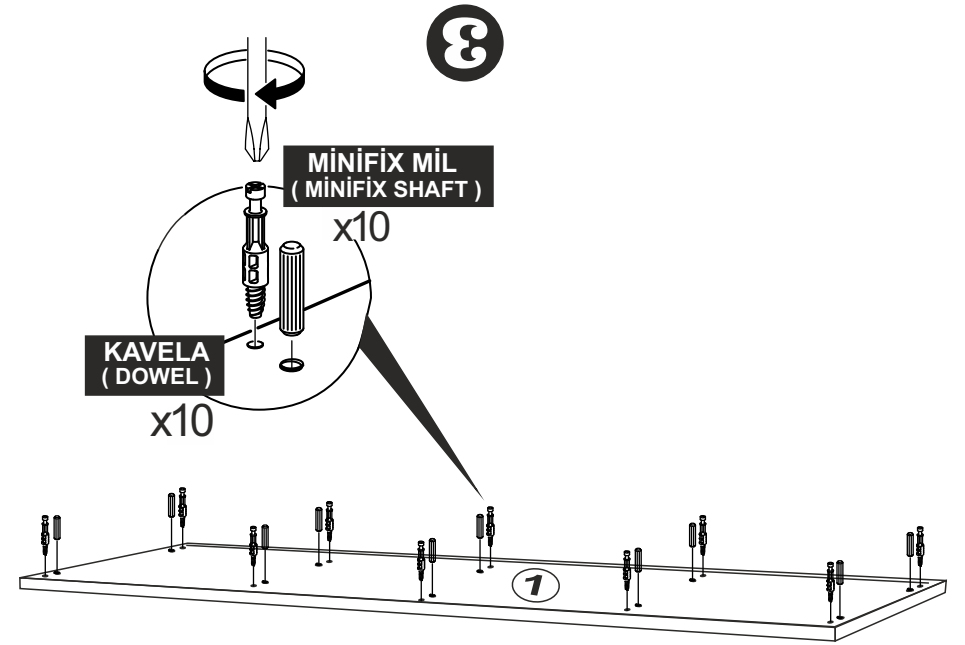
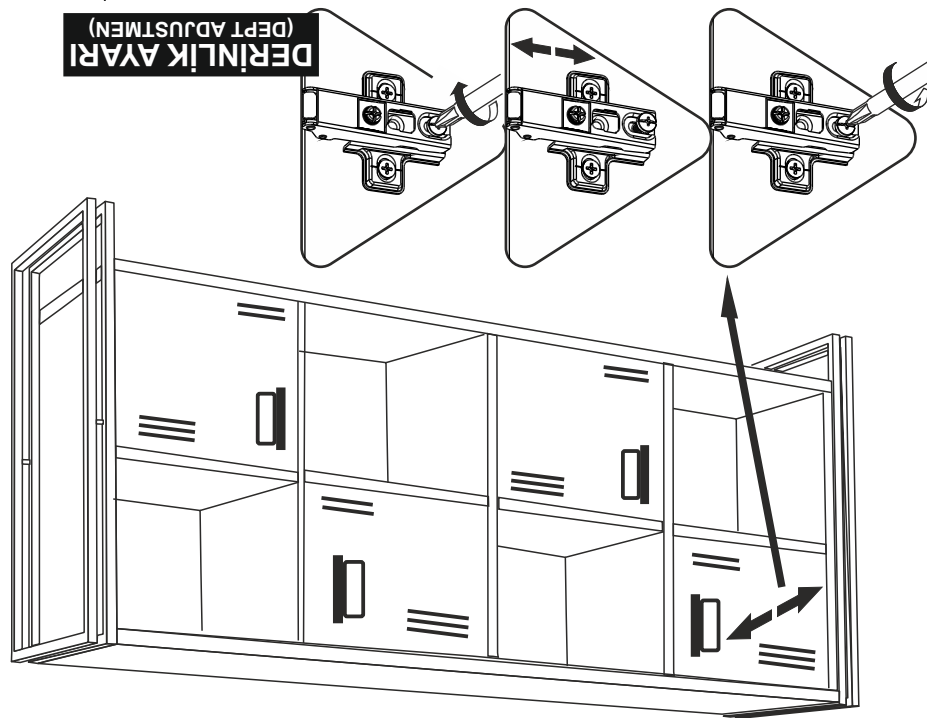
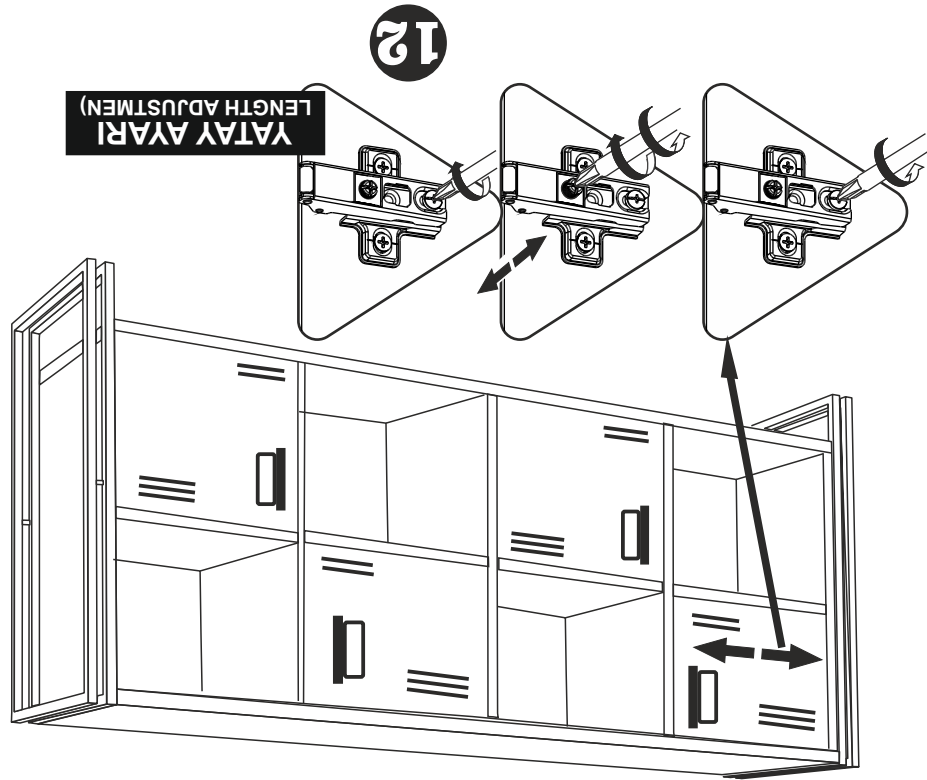

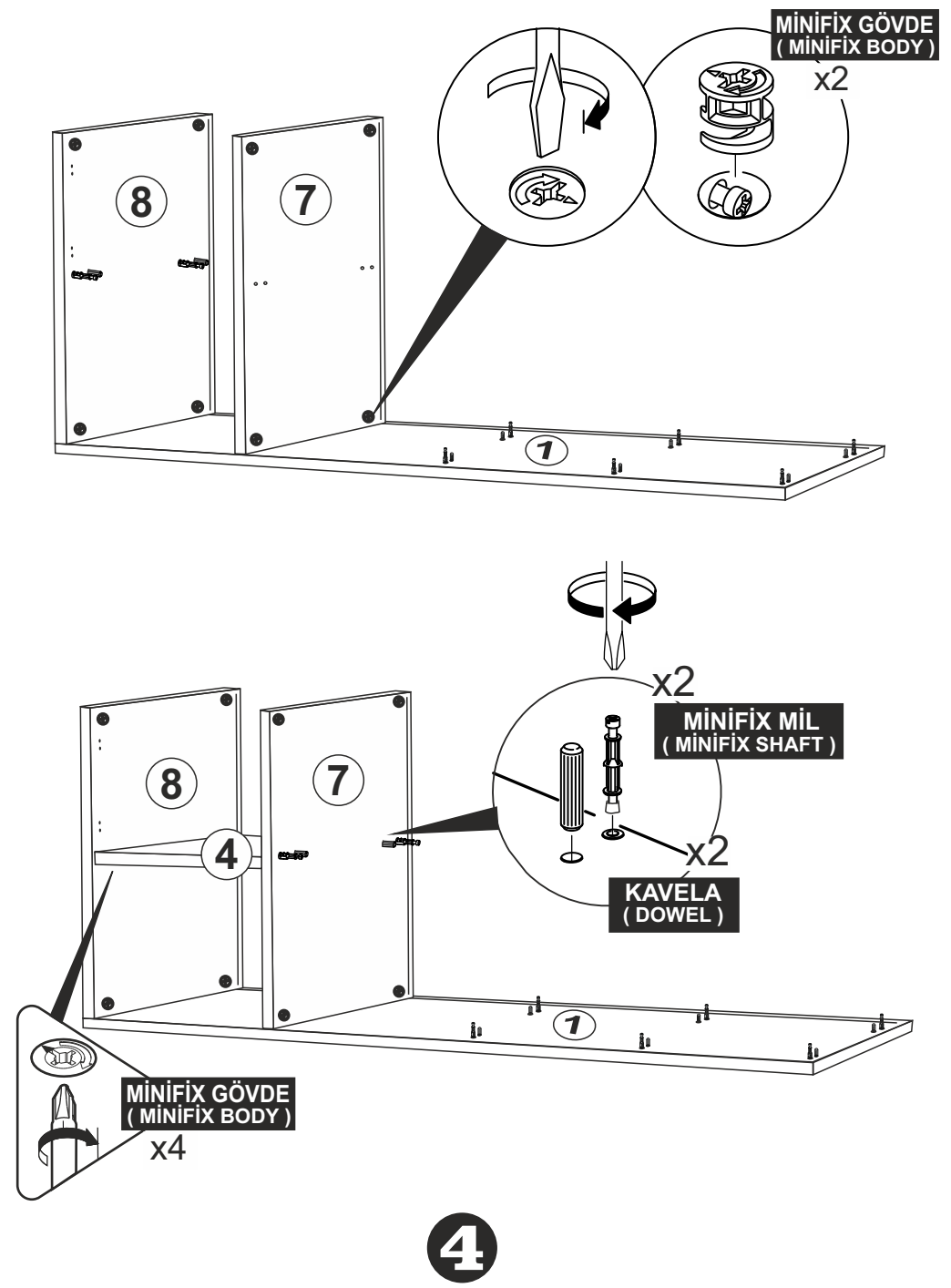
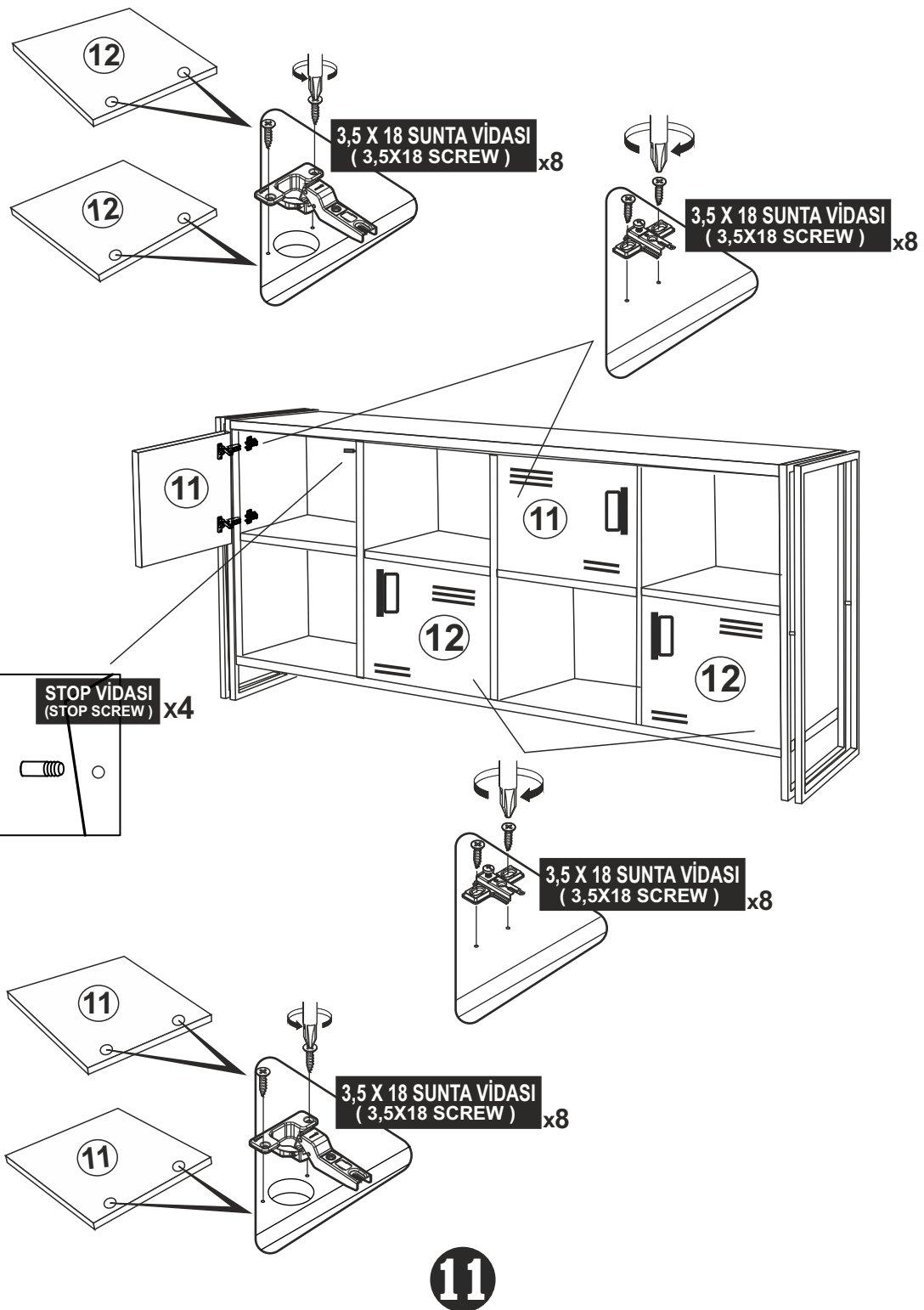

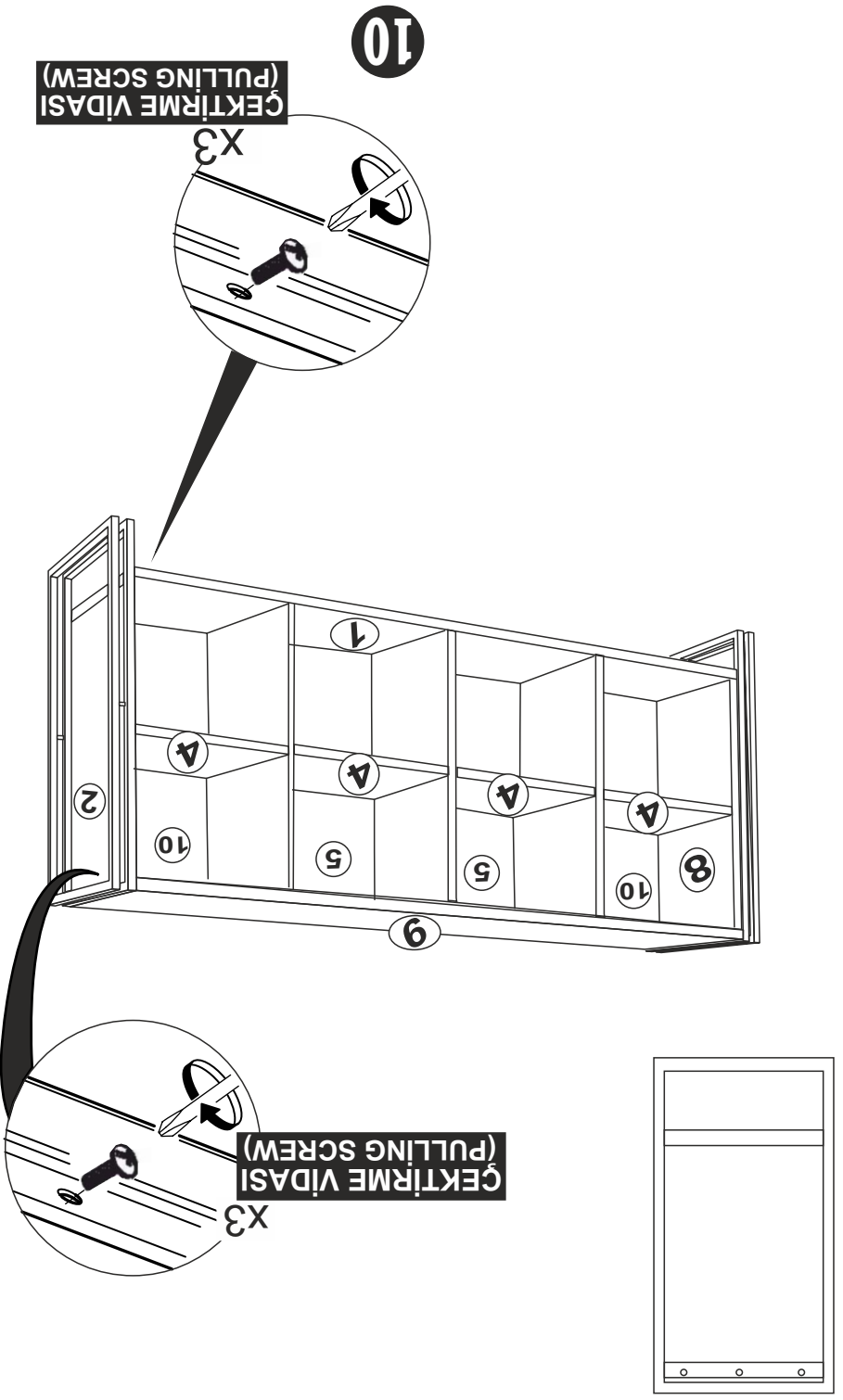
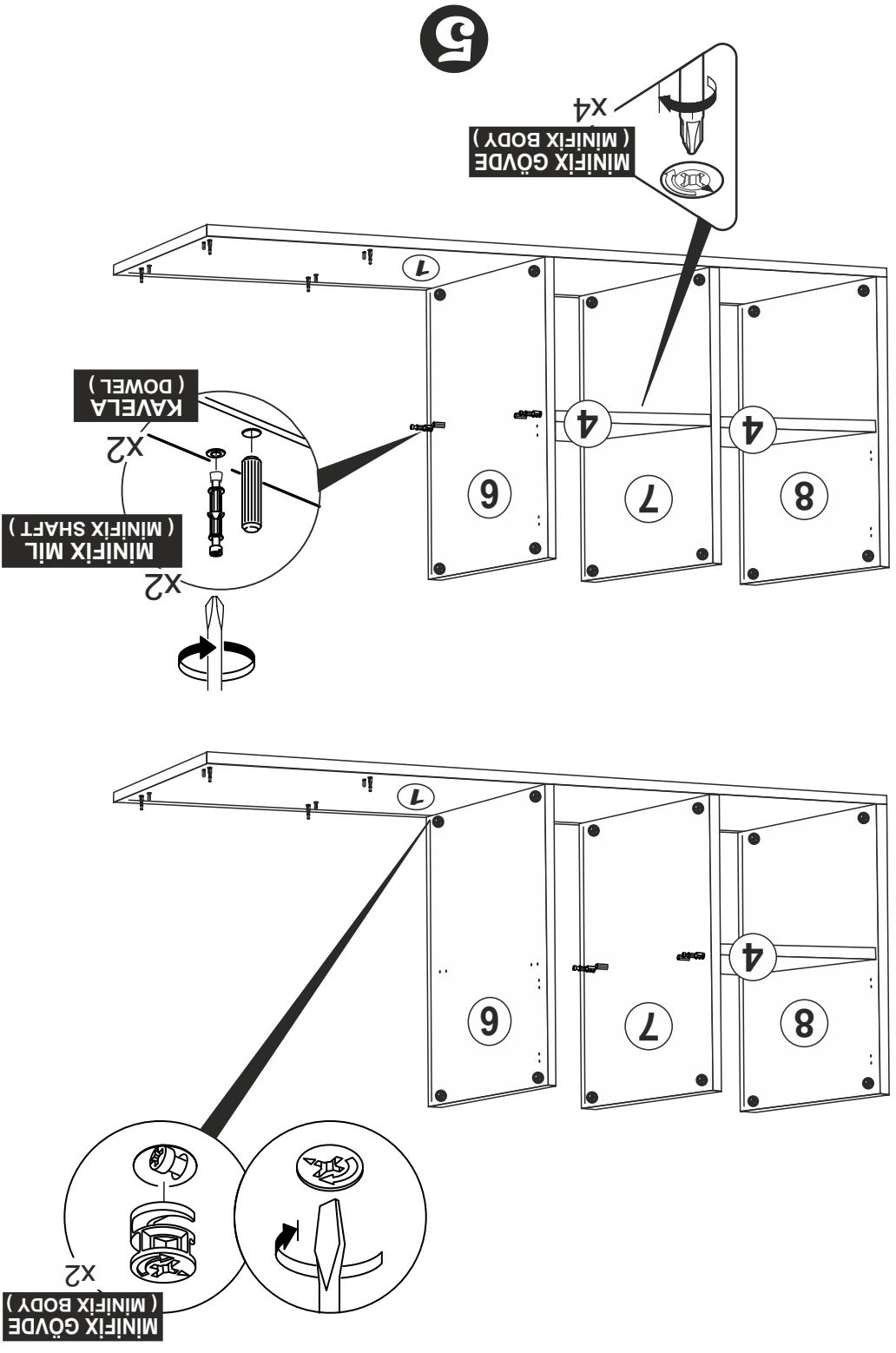

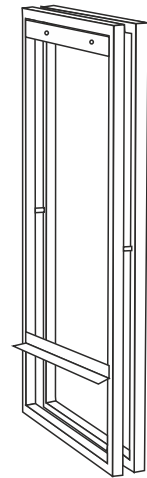
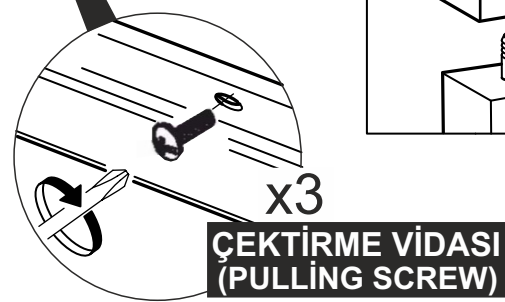
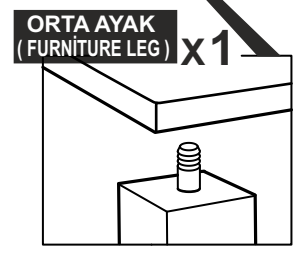
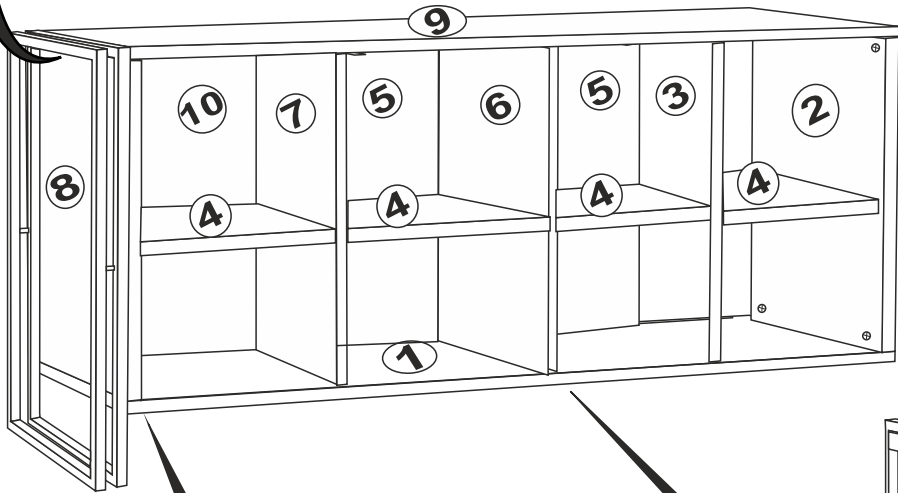
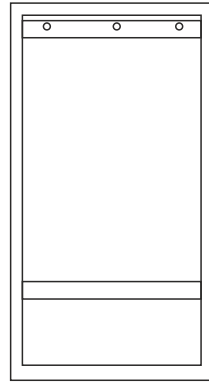
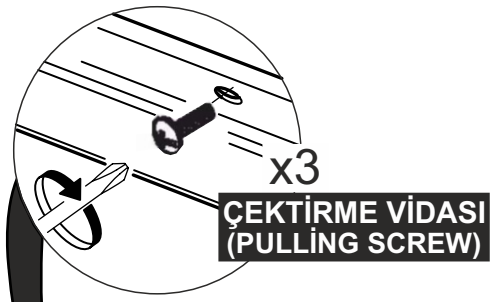

9

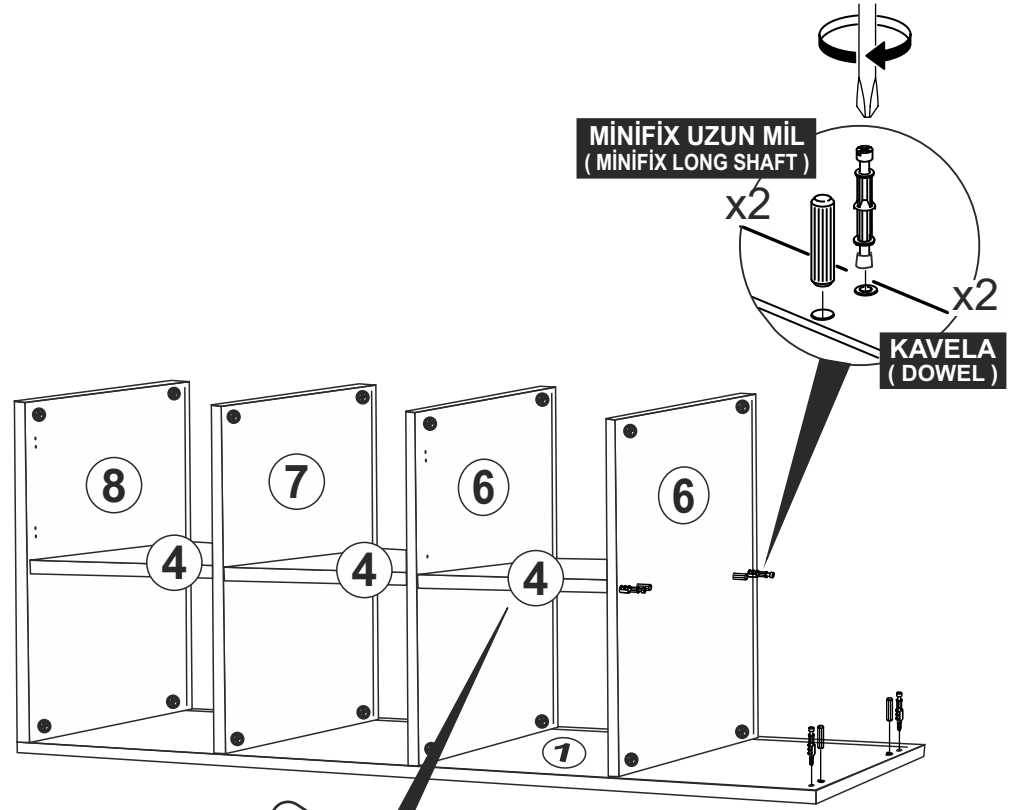
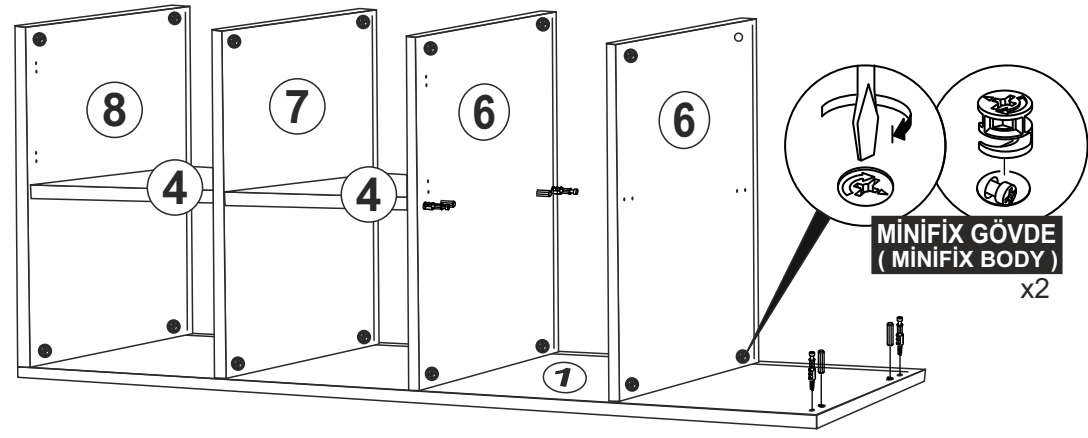

6

