

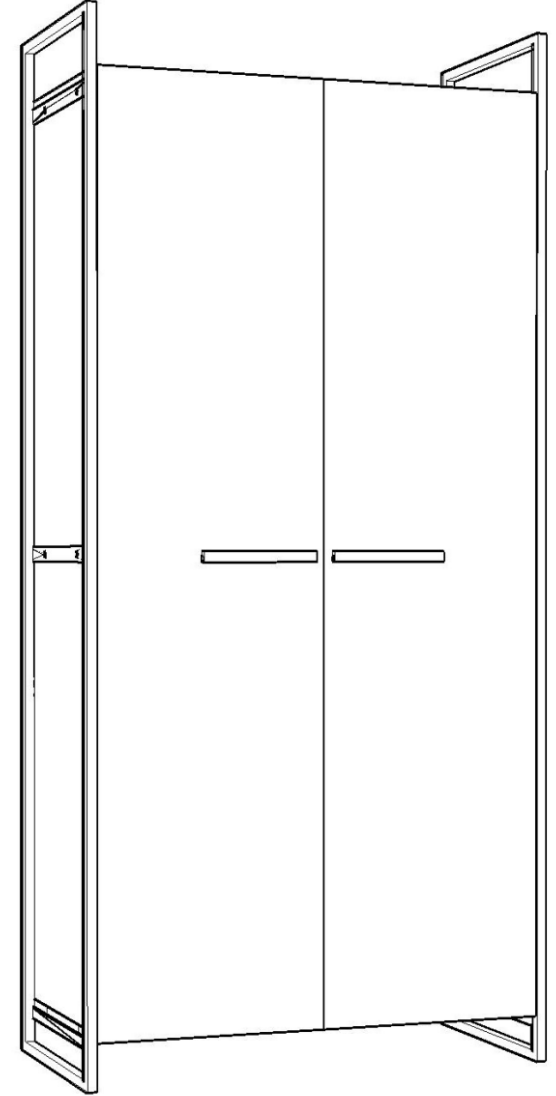









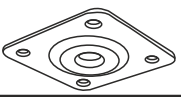



DYNAMIC 07
2 KAPAKLI DOLAP MODÜL
KURULUM ŞEMASI
ASSEMBLY GUIDE

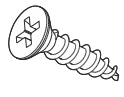

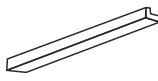
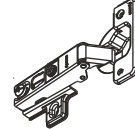
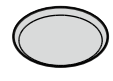
1

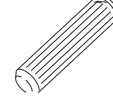
* AKSESUARLARI GÖSTERİLDİĞİ GİBİ DÜZ BİR ZEMİN ÜZERİNDE TAKINIZ...
* ÜRÜNÜ KURARKEN MONTAJ SIRASINI TAKİP EDİNİZ
* FİX THE ACCESSORIES AS SHOWN FOLLOW THE
INSTALLATION SEQUENCE WHILE INSTALLING THE PRODUCT.

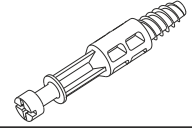
 MODÜL BİRLEŞTİRME APARATI X 4 BLACK SİYAH	 KARE AYAK SACI x 1 (IRON)	 RAF PİMİ x 12 (PLASTIC PIN)	 ORTA AYAK x 1 (FURNITURE LEG) 10 cm
 ÇEKİRME VIDASI x 12 (PULLING SCREW)	 PULLU VIDA x 5 (SCREW)	 ARKALIK KÖŞE x 14 (CORNER WEDGE)	 3,5 X 18 SUNTA VIDASI X58 (3,5X18 SCREW)
 KULP VIDASI x 4 (HOLDER SCREW)	 192 LİK KULP x 2 (HOLDER)	 DÜZ MENTEŞE x 8 (HINGE)	 AYAK KEÇESİ x 4 (FOOT SEAL)
 DÜBEL x 36 (PEG)	 KAVELA x 24 (DOWEL)	 MİNİFİX GÖVDE x 24 (MİNİFİX BODY)	 MİNİFİX MİL x 24 (MİNİFİX SHAFT)

AKSESUAR LİSTESİ / ACCESSORY LIST

Bu modül iki kişi tarafından kurulmalıdır.
This unit should be assembled by two persons.
/ Bu modülün kurulumu için gerekli olan araçlar.
The necessary tools (not included)

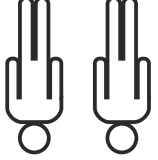

14

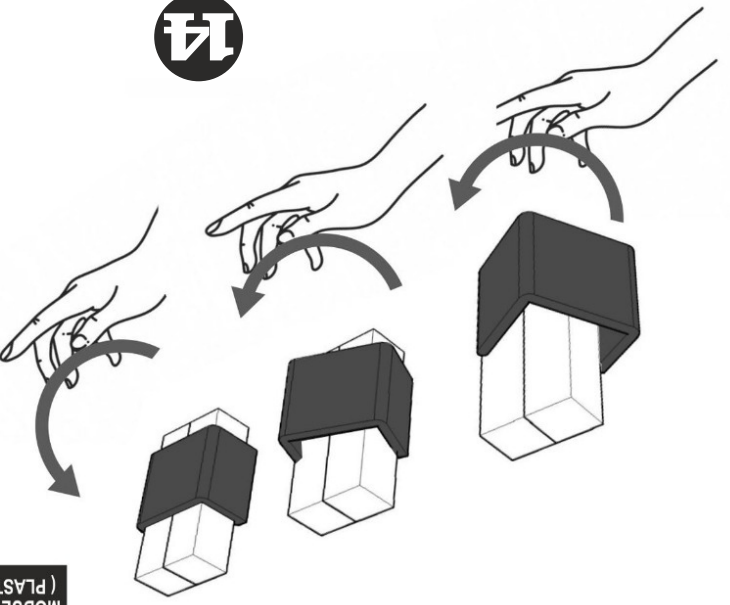

MODÜL BİRLEŞTİRME APARATI (PLASTIC MODULE FIXING)
X4

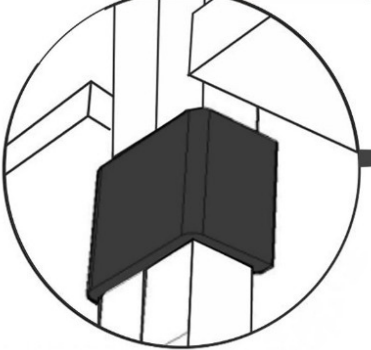

MODÜL BİRLEŞTİRME DETAYI
(MODULE FIXING DETAIL)

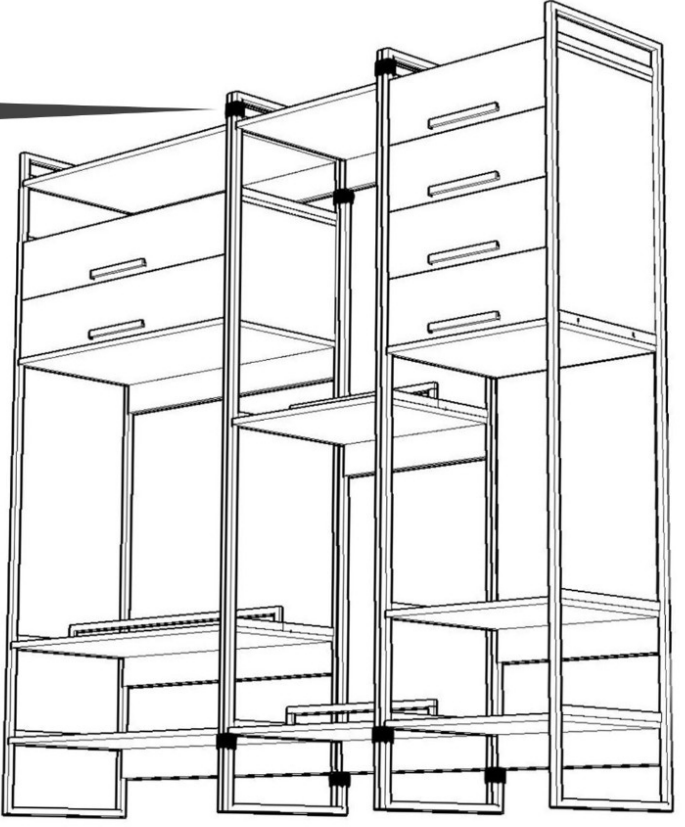

DERİNLİK AYAR
(DEPT ADJUSTMEN)

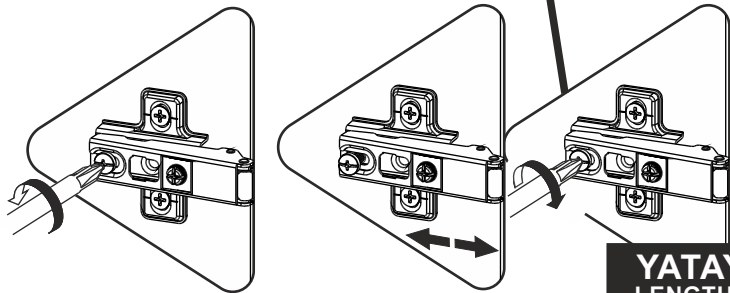
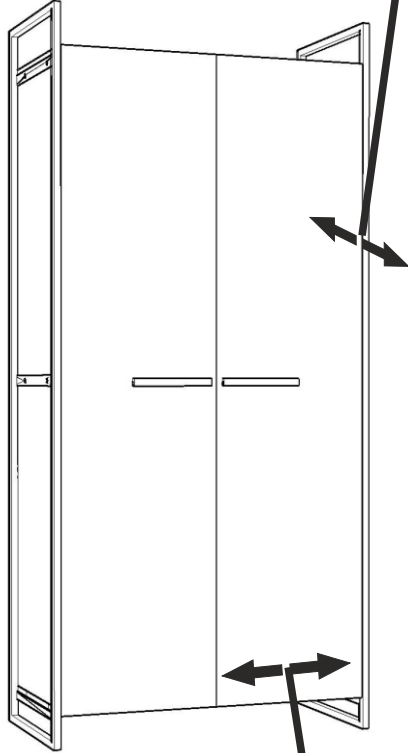
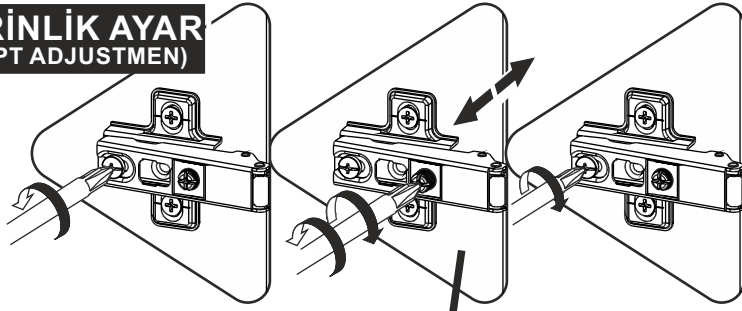

YATAY AYARI
LENGTH ADJUSTMEN

13

DİKKAT !! / ATTENTION !!

Minifiks ve Kavela ürünlerimizde kullanılan ana bağlantı malzemesidir. Montaja başlamadan önce lütfen aşağıdaki çizimleri kontrol ederek, anlamaya çalışın...

Minifix and Dowel is the main connection material used in products. Before starting assembly, please check the drawings below...

Minifix Dübeli

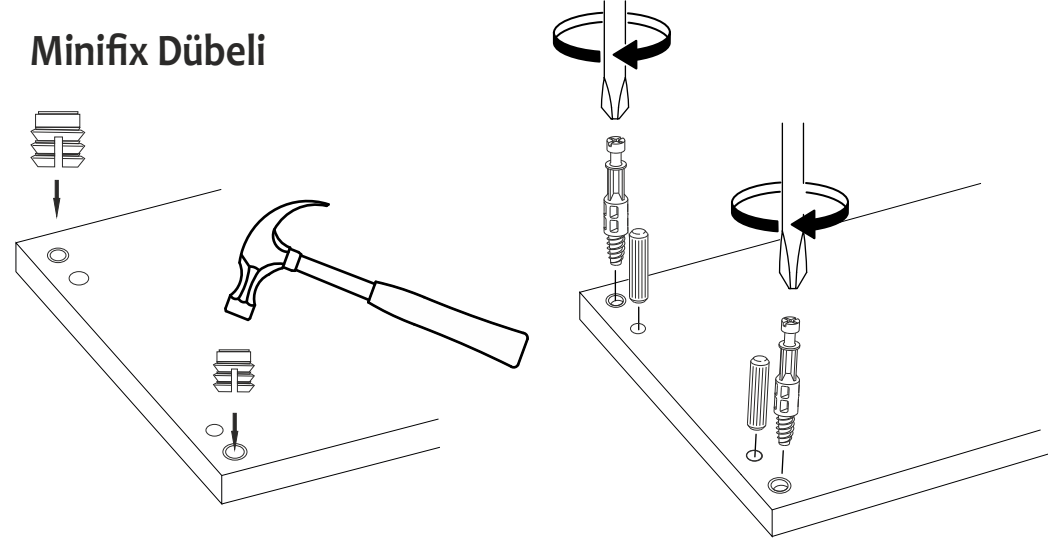

Minifix Gövde
(MINIFIX BODY)

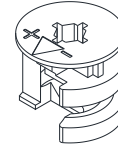

Minifix Mil
(MINIFIX SHAFT)

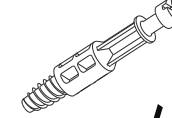

Kavela
(DOWEL)

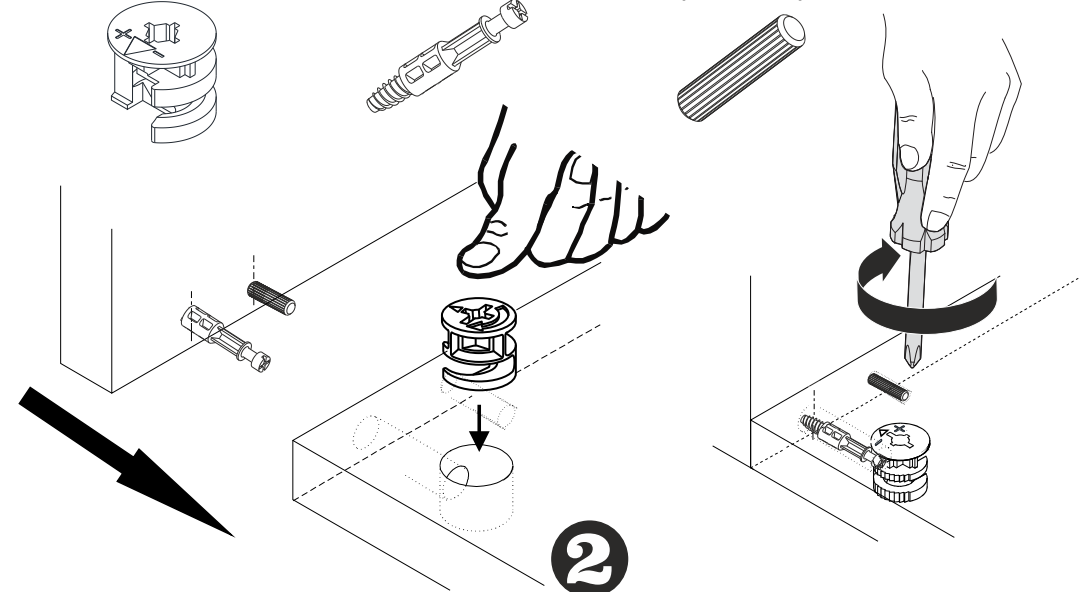
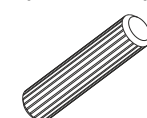

3

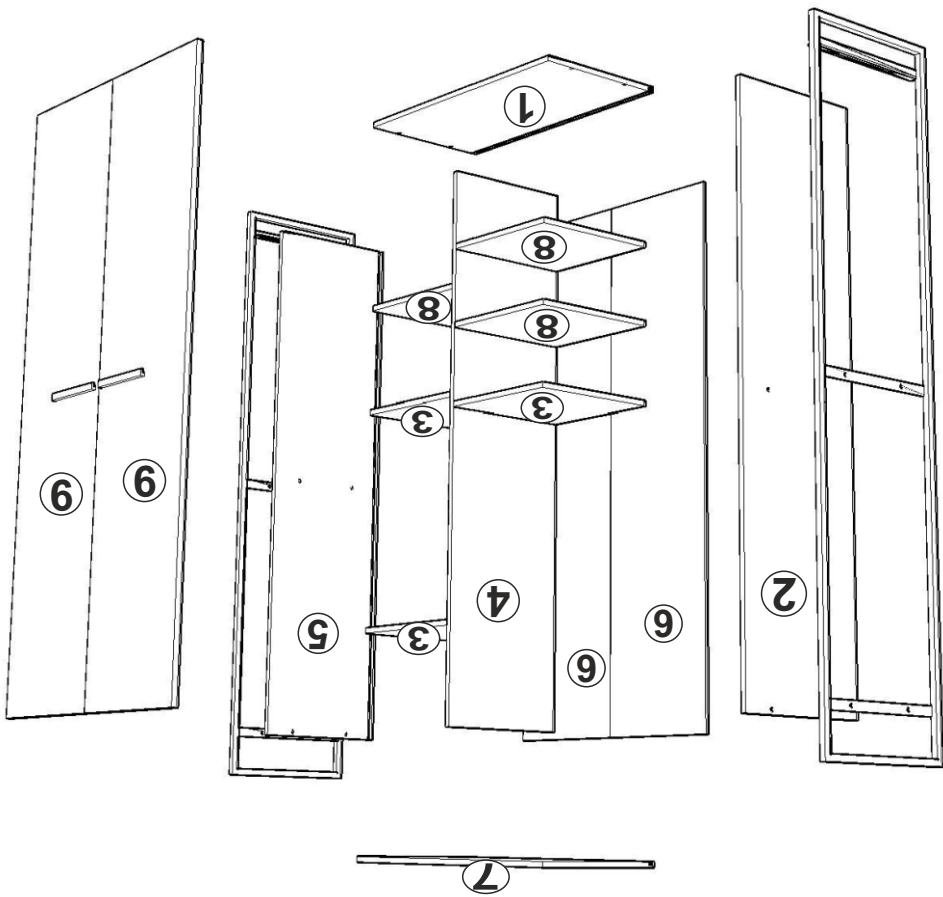

12

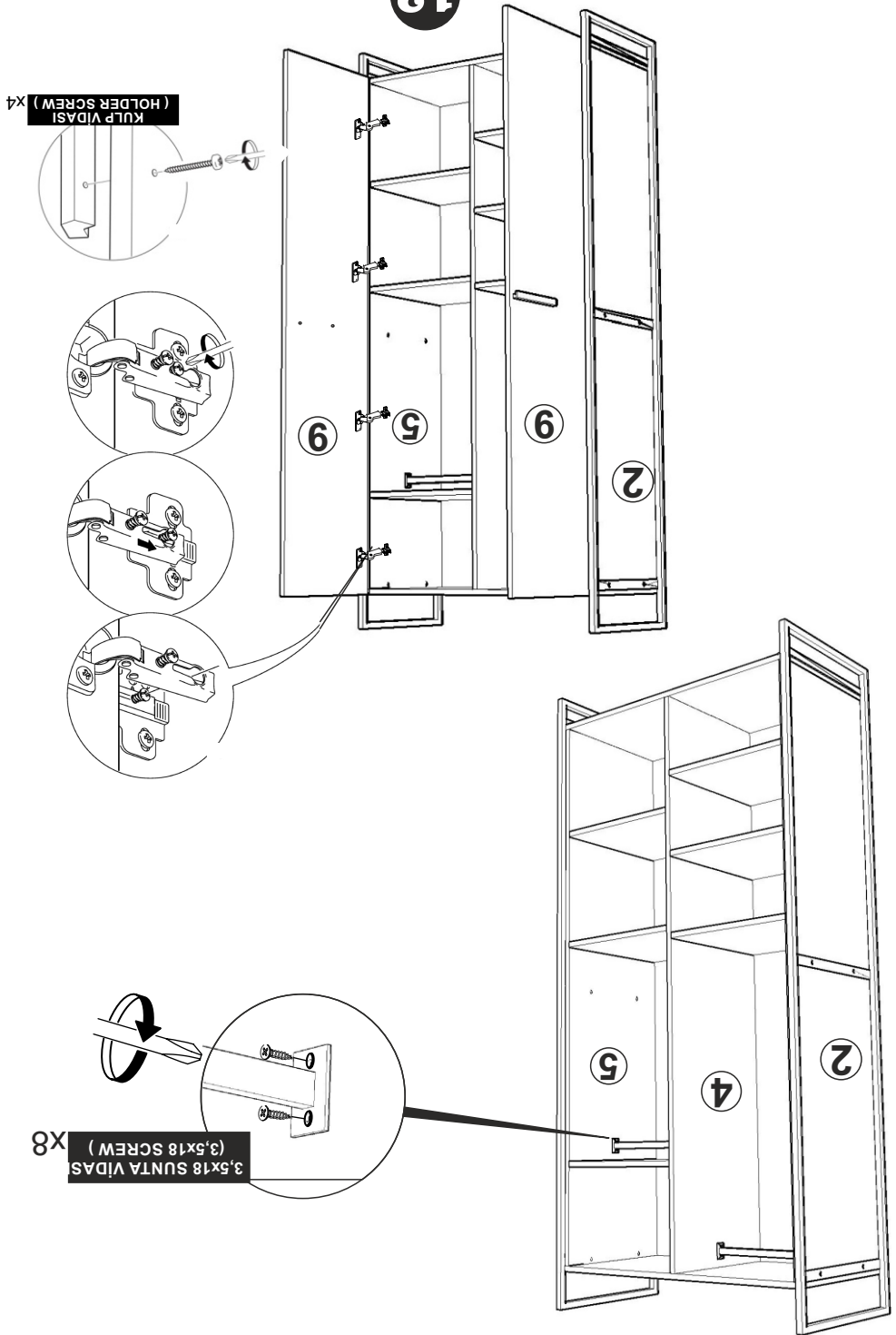

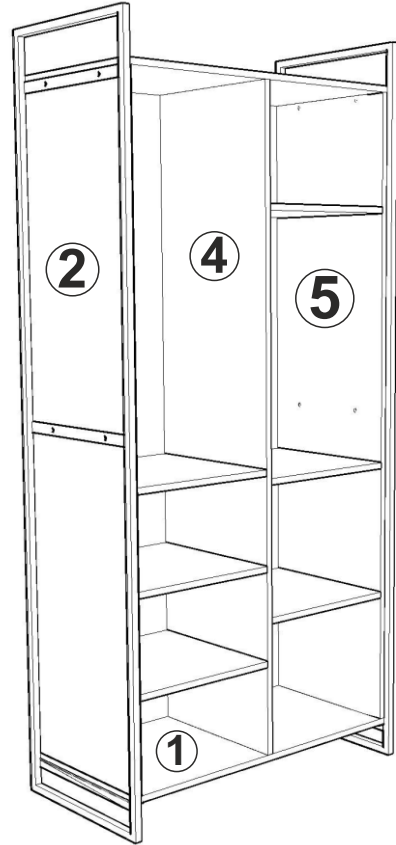
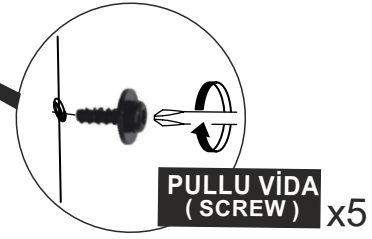
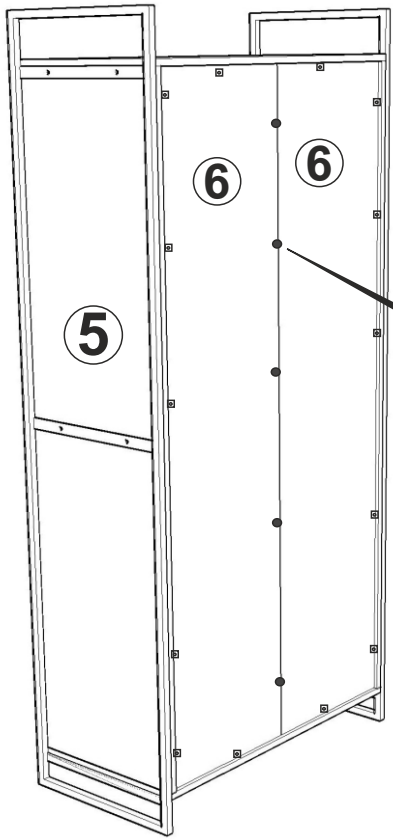

11

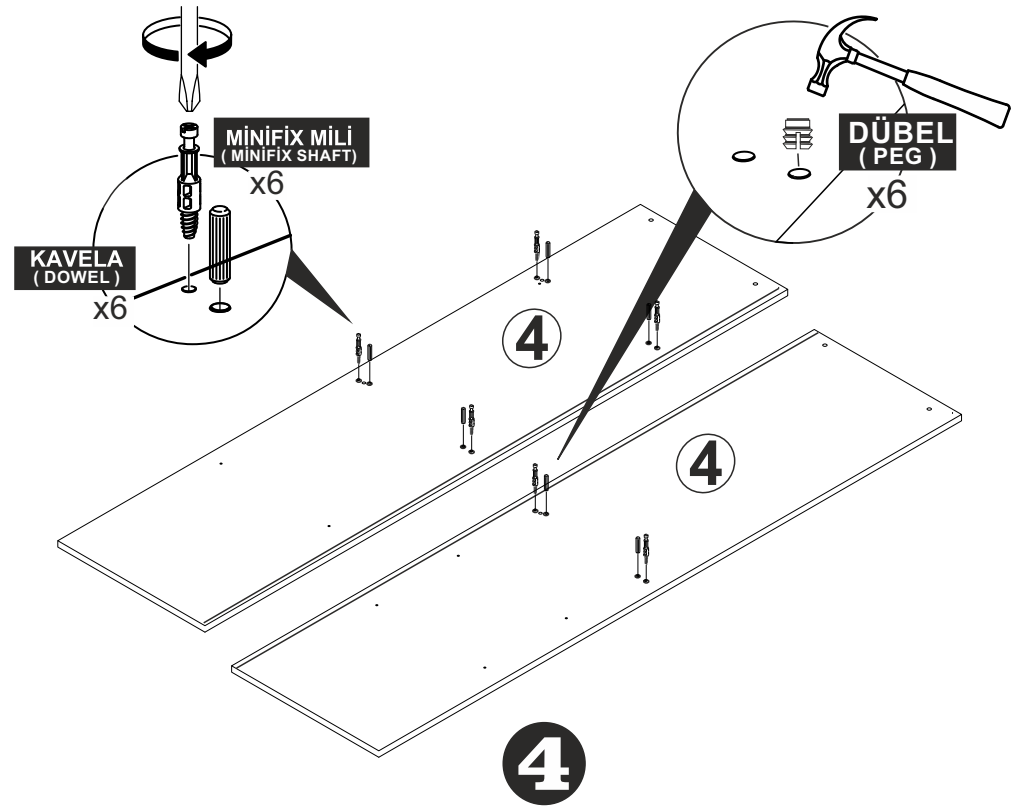
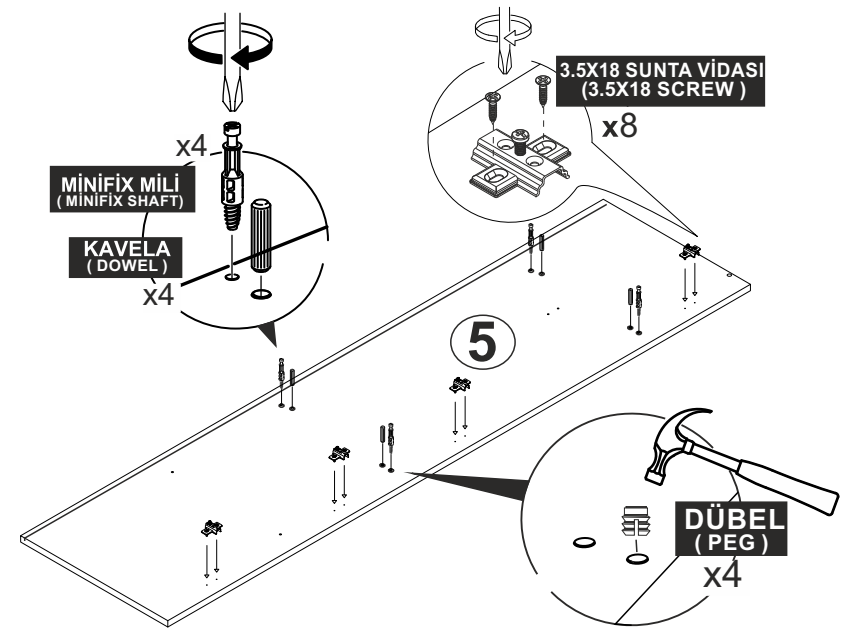

4

