

SANDALYE

KURULUM ŐEMASI

ASSEMBLY GUIDE

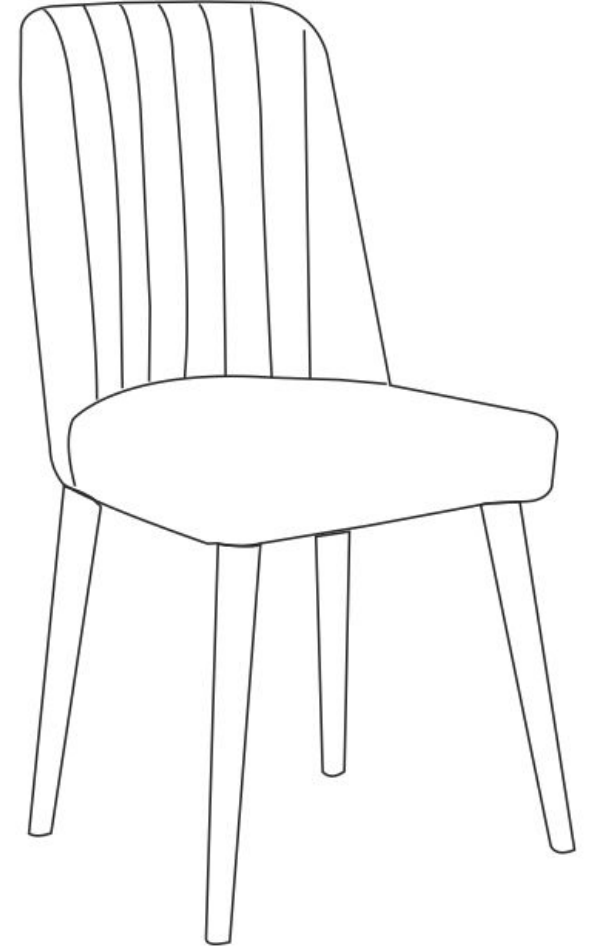

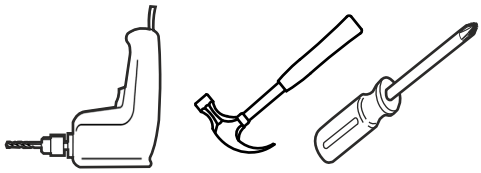







Bu modül iki kişi tarafından kurulmalıdır.
This unit should be assembled by two persons.

Bu modülün kurulumu için gerekli olan araçlar.
The necessary tools (not included)

AKSESUAR LİSTESİ / ACCESSORY LIST

			
AYAK DEMİRİ X 4 (IRON)	AHŞAP AYAK X 4 (FURNITURE LEG)	SOMUN X 4 (BOLD NUT)	6x15 VIDA X 16 (6x15 SCREW)
			
ANAHTAR X 1 (WRENCH)	AYAK KEÇESİ X 4 (FOOT SEAL)	3,5 x 25 SUNTA VIDASI X 12 (3,5 x 25 SCREW)	

* AKSESUARLARI GÖSTERİLDİĞİ GİBİ DÜZ BİR ZEMİN ÜZERİNDE TAKINIZ...
* ÜRÜNÜ KURARKEN MONTAJ SIRASINI TAKİP EDİNİZ
* FİX THE ACCESSORIES AS SHOWN FOLLOW THE
INSTALLATION SEQUENCE WHILE INSTALLING THE PRODUCT.

1

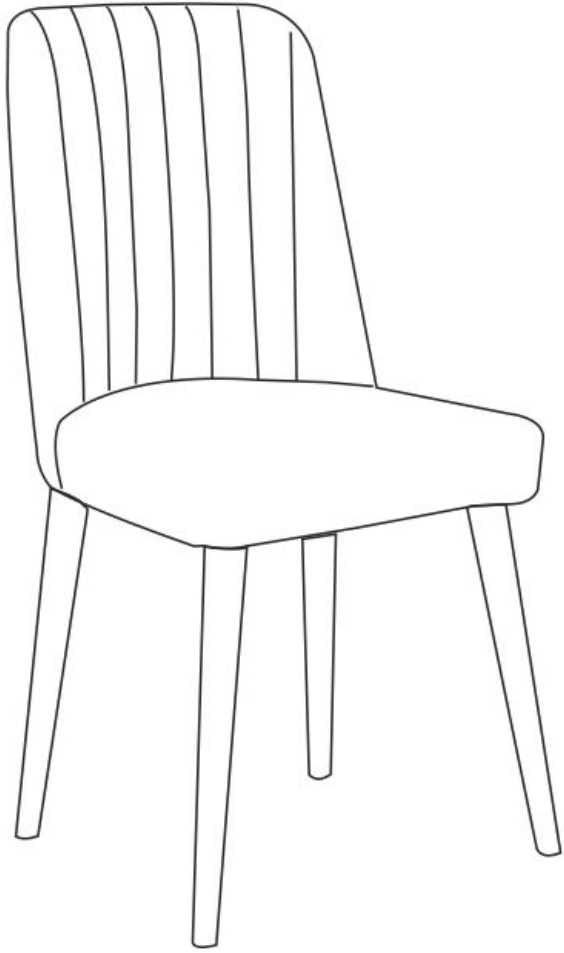

5

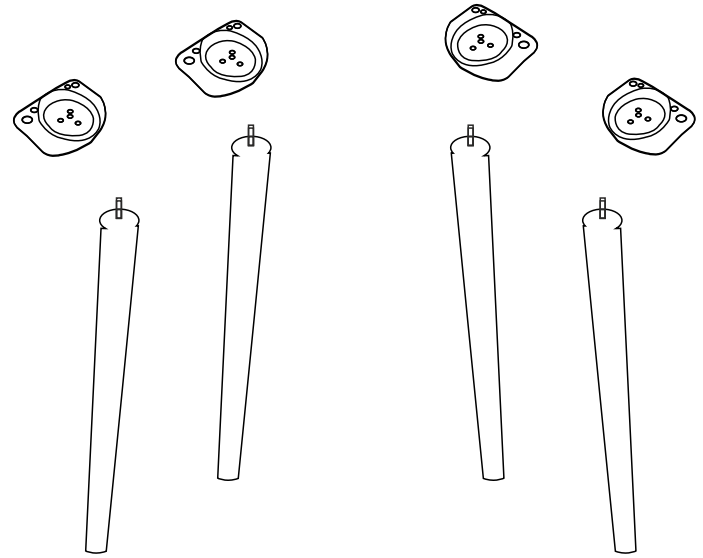
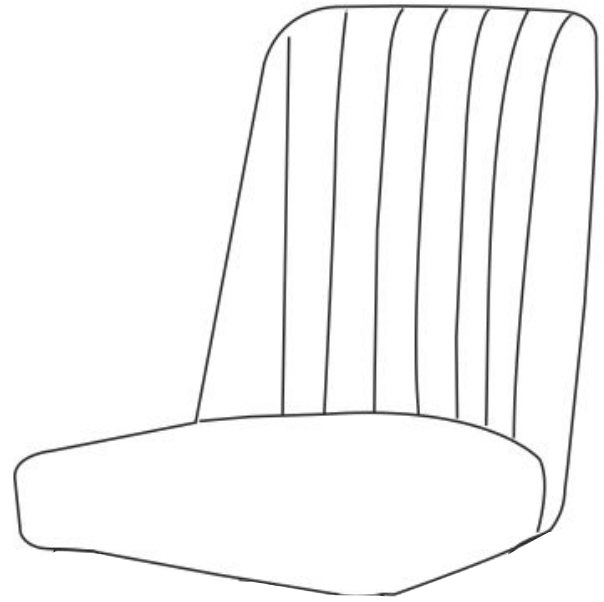

2

