

VİNA KUMAŞLI SANDIKLI BANK KURULUM ŞEMASI

ASSEMBLY GUIDE

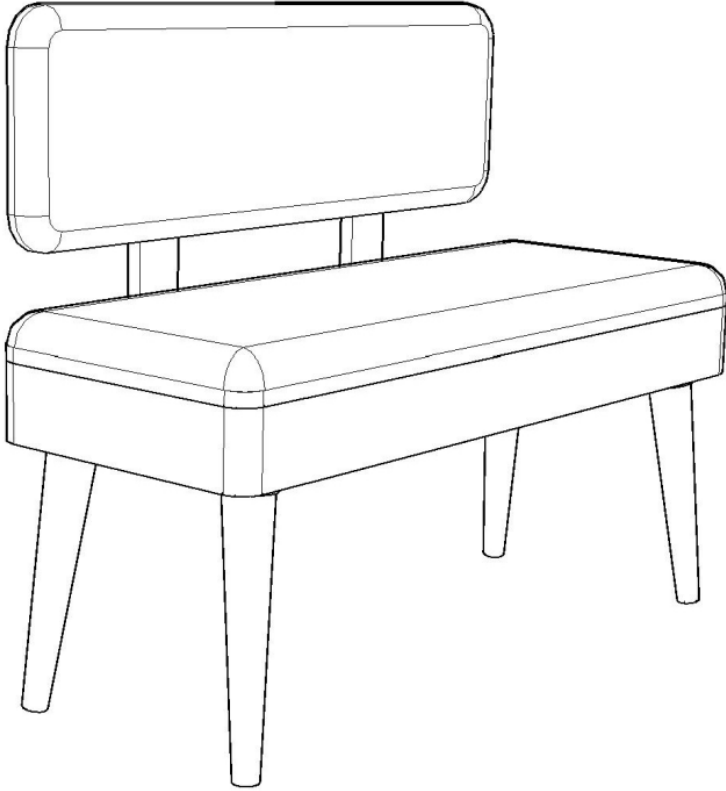

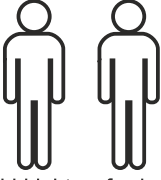

Bu modül iki kiři tarafından kurulmalıdır.
This unit should be assembled by two persons.

Bu modülün kurulumu için gerekli olan araçlar.
The necessary tools (not included)

AKSESUAR LİSTESİ / ACCESSORY LIST

 HM02269 M6 X 50 YSB VİDA x 4 (SCREW)	 HM02295 BANK SIRT PAPEL X 2 (FURNİTURE LEG)	 HM02090 M6 X 30 YSB VİDA x 4 (SCREW)	 HM02088 M6 SOMUN x 4 (BOLD NUT)
 HM02095 YAPIŞKAN KEÇE x 4 (FOOT SEAL)	 (SİYAH) HM02097 6x15 RYSB VİDA X 16 (6x15 SCREW)	 HM51039 AYAK SACI X 4 (İRON)	 HM02339 33 CM AHŞAP AYAK X 4 (FURNİTURE LEG)

* AKSESUARLARI GÖSTERİLDİĞİ GİBİ DÜZ BİR ZEMİN ÜZERİNDE TAKINIZ...

* ÜRÜNÜ KURARKEN MONTAJ SIRASINI TAKİP EDİNİZ

* FİX THE ACCESORIES AS SHOWN FOLLOW THE
INSTALLATION SEQUENCE WHILE INSTALLING THE PRODUCT.

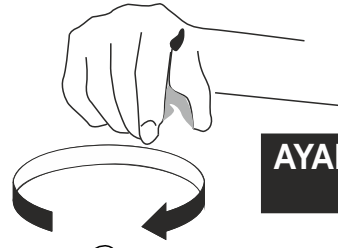

**AYAK DEMİRİ X 4
(IRON)**

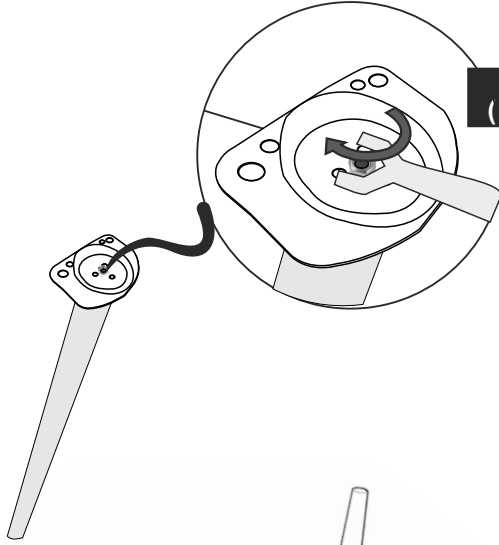
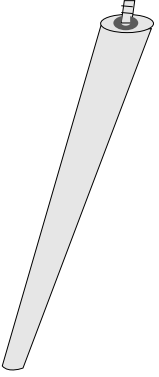
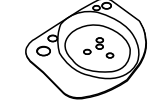

**SOMUN X 4
(BOLD NUT)**

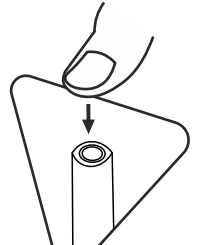

**YAPIŞKAN KEÇE x 4
(FOOT SEAL)**

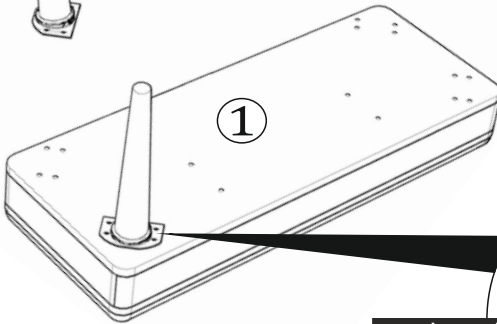

1

**ÇEKTİRME VİDASI
(PULLING SCREW)**

x16



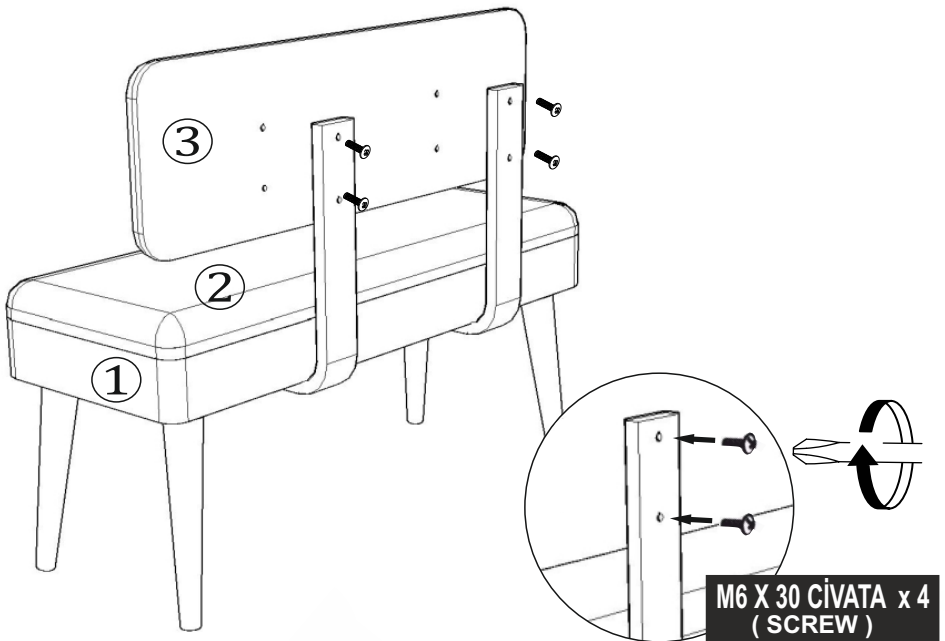
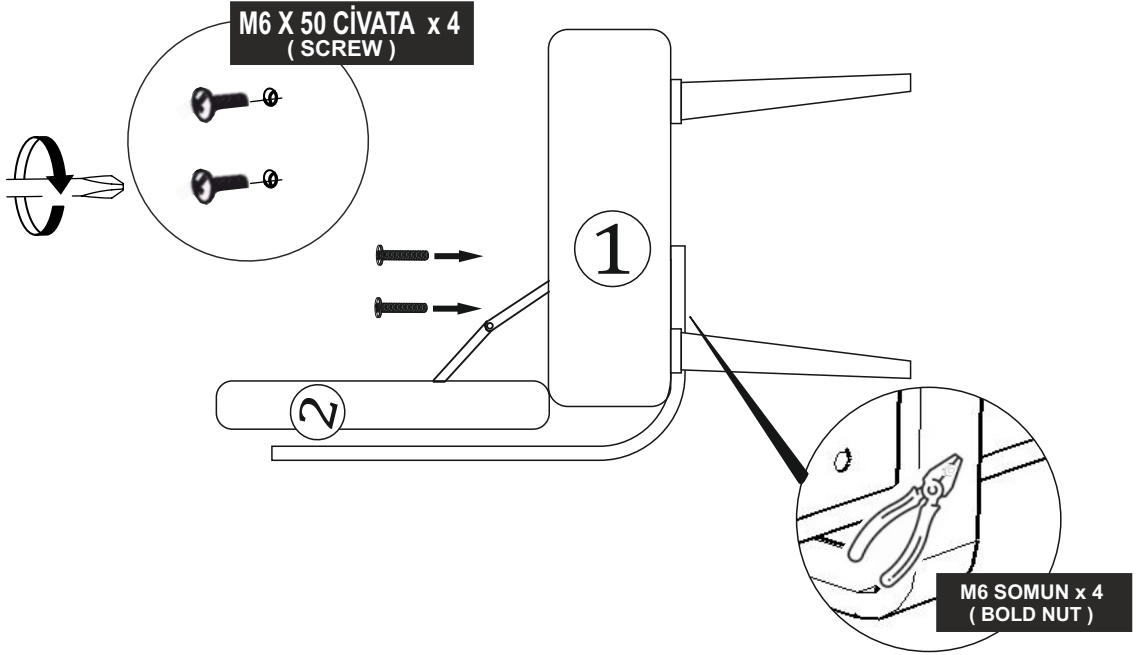

3

* BU SAYFA BİLGİLENDİRME AMAÇLIDIR.

* ÜRÜN KİSMİ KURULUM GEREKTİRDİĞİ İÇİN BURADAKİ AKSESUARLARA GEREKSİNİM DUYULMABİLİR.







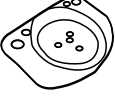
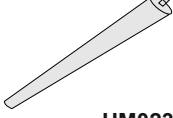

* ÜRÜNÜN HASARLI VEYA EKSİK PARÇASININ TESPİTİ İÇİNDİR.

* THIS PAGE IS FOR INFORMATION PURPOSES.

* SINCE THE PRODUCT REQUIRES PARTIAL INSTALLATION, THE ACCESSORIES HERE MAY NOT BE NEEDED.

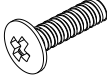
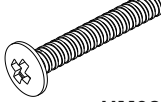
* FOR THE DETECTION OF MISSING OR DAMAGED PART OF THE PRODUCT.

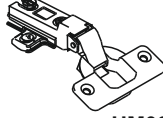
AKSESUAR KODLAMA / ACCESSORIES CODE

 HM51039	 HM02339	 HM02088	 HM51198
AYAK SACI X 4 (İRON)	33 CM AĖŞAP AYAK X 4 (FURNİTURE LEG)	M6 SOMUN x 4 (BOLD NUT)	M6 ZAMAK SOMUN X 4 (BOLD NUT)
 HM02150	 HM02090	 HM02269	 (SİYAH) HM02097
4X20 SUNTA VİDASI X 8 (4X20 SCREW)	M6 X 30 YSB VİDA x 4 (SCREW)	M6 X 50 YSB VİDA x 4 (SCREW)	6x15 RYSB VİDA X 16 (6x15 SCREW)
 HM02095	 HM02040	 HM02297	 HM02295
YAPIŞKAN KEÇE X 4 (FOOT SEAL)	DÜZ MENTEŞE X 2 (HINGE)	PİKAP MAKASI X 2 (SCISSORS)	BANK SIRT PAPEL X 2 (FURNİTURE LEG)

PARÇA KODLAMA / GENERAL VIEW

