

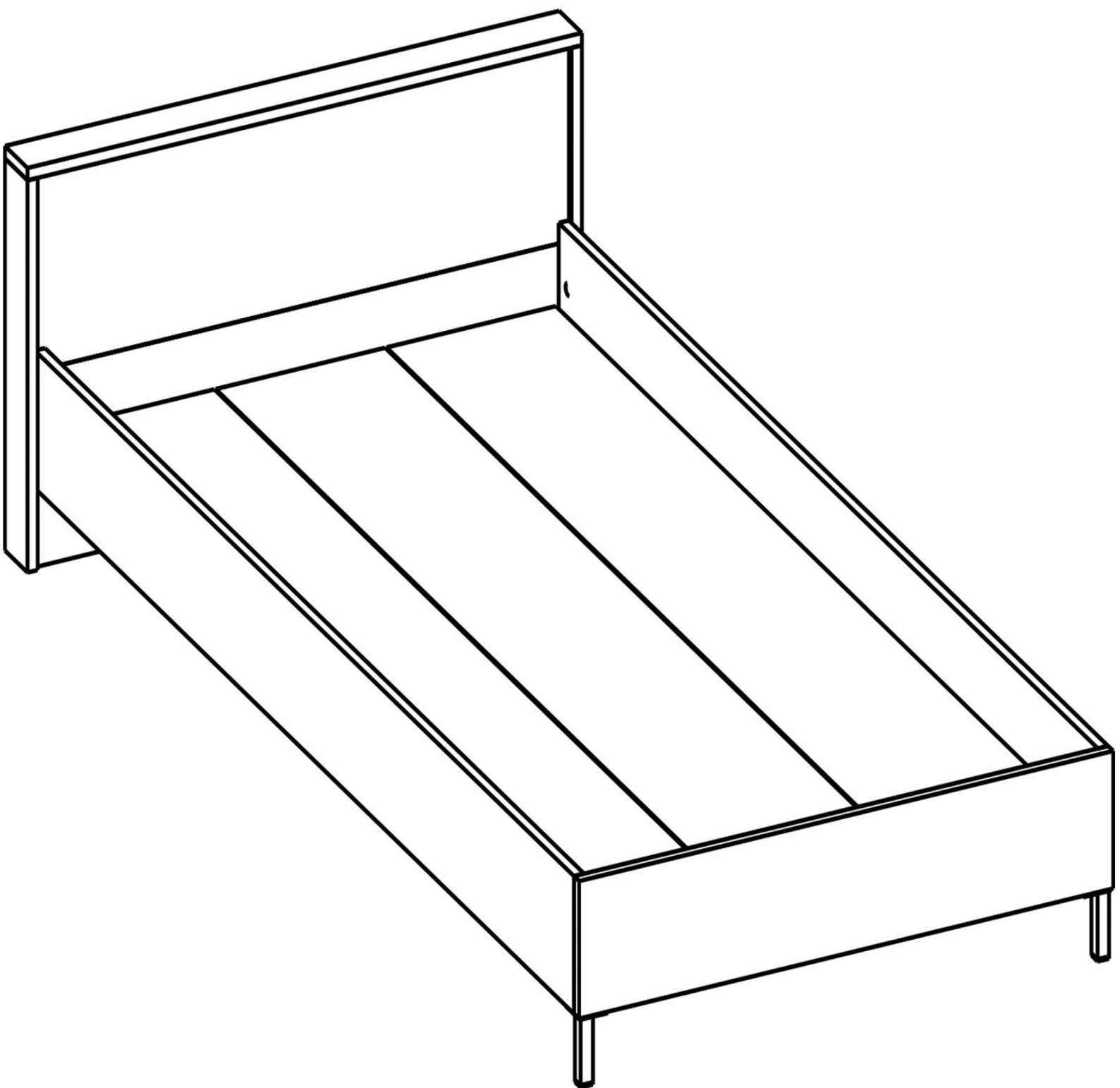

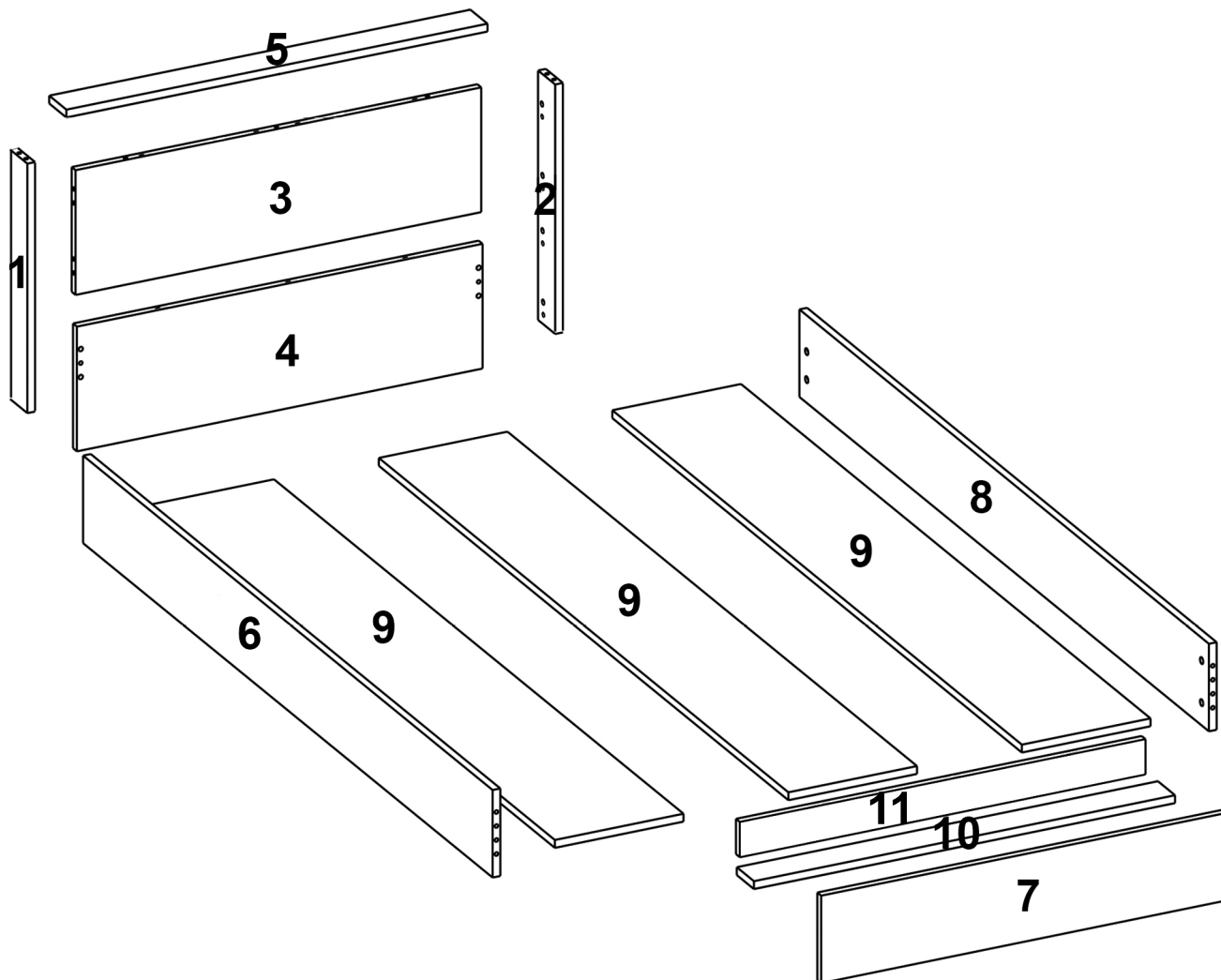







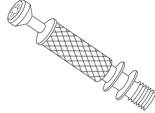



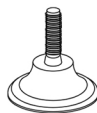

# HM4



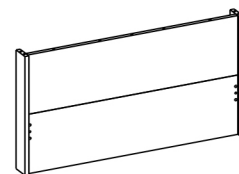

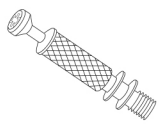
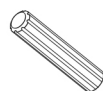
 28x B0502	 23x B0504	 26x B0503	 2x D0154	 12x B0309	 3x D0501
 6x B0301	 35x B0501	 2x B1702	 3x B0505	 4x B0303	 3x B0304





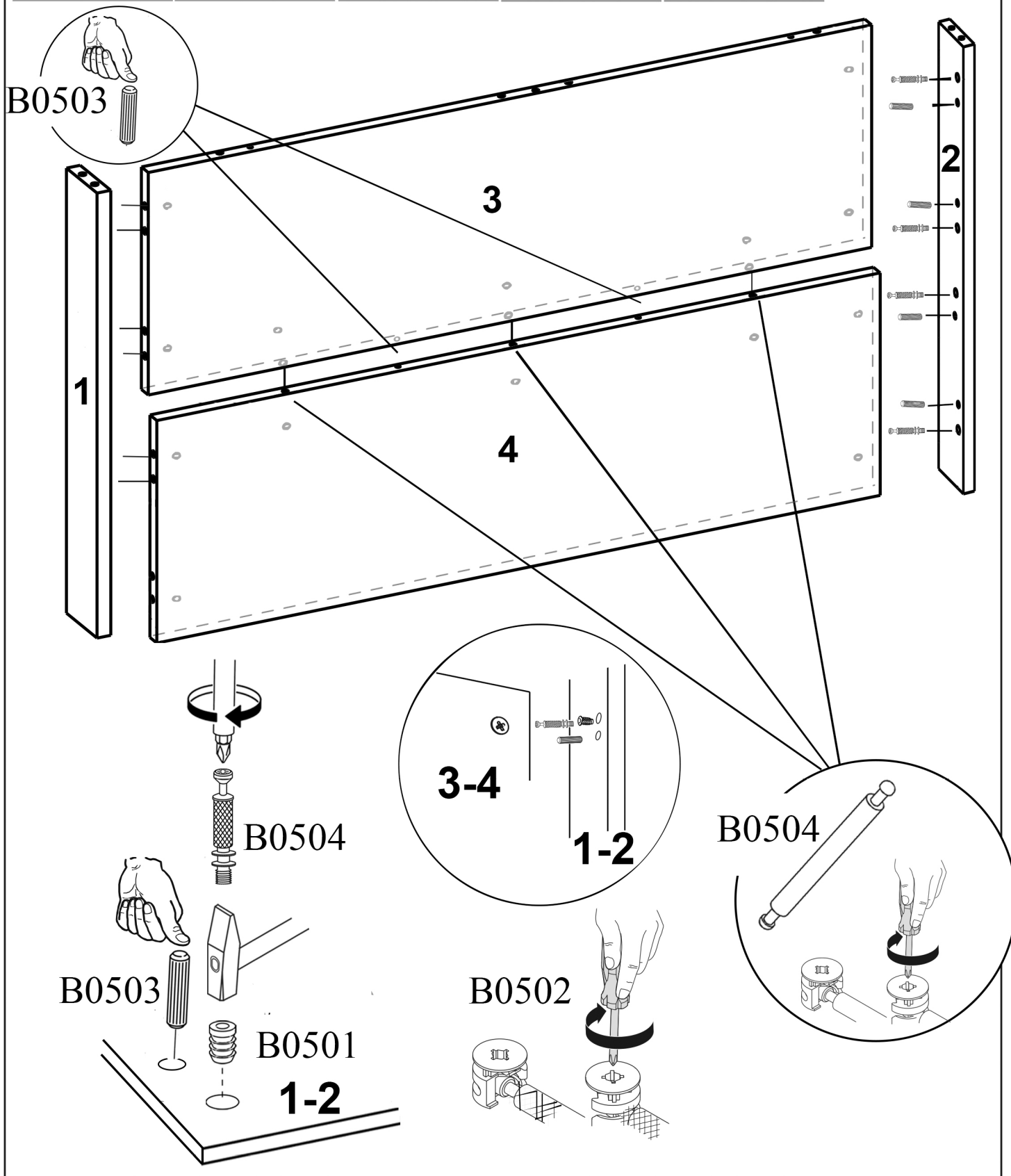

 8x B0504	 10x B0503	 8x B0501	 14x B0502	 3x B0505
---	--	---	--	---

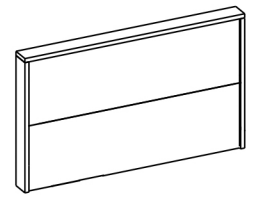

3/8

# HM4

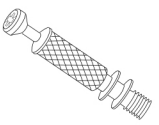

 8x B0503	 3x B0504
 3x B0501	
 3x B0502	

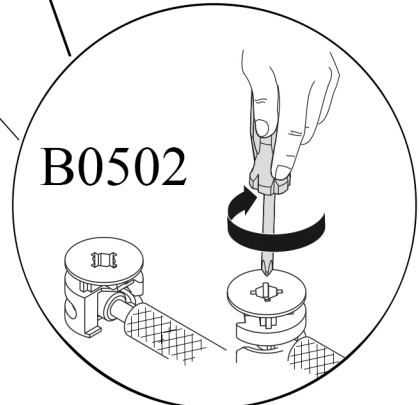
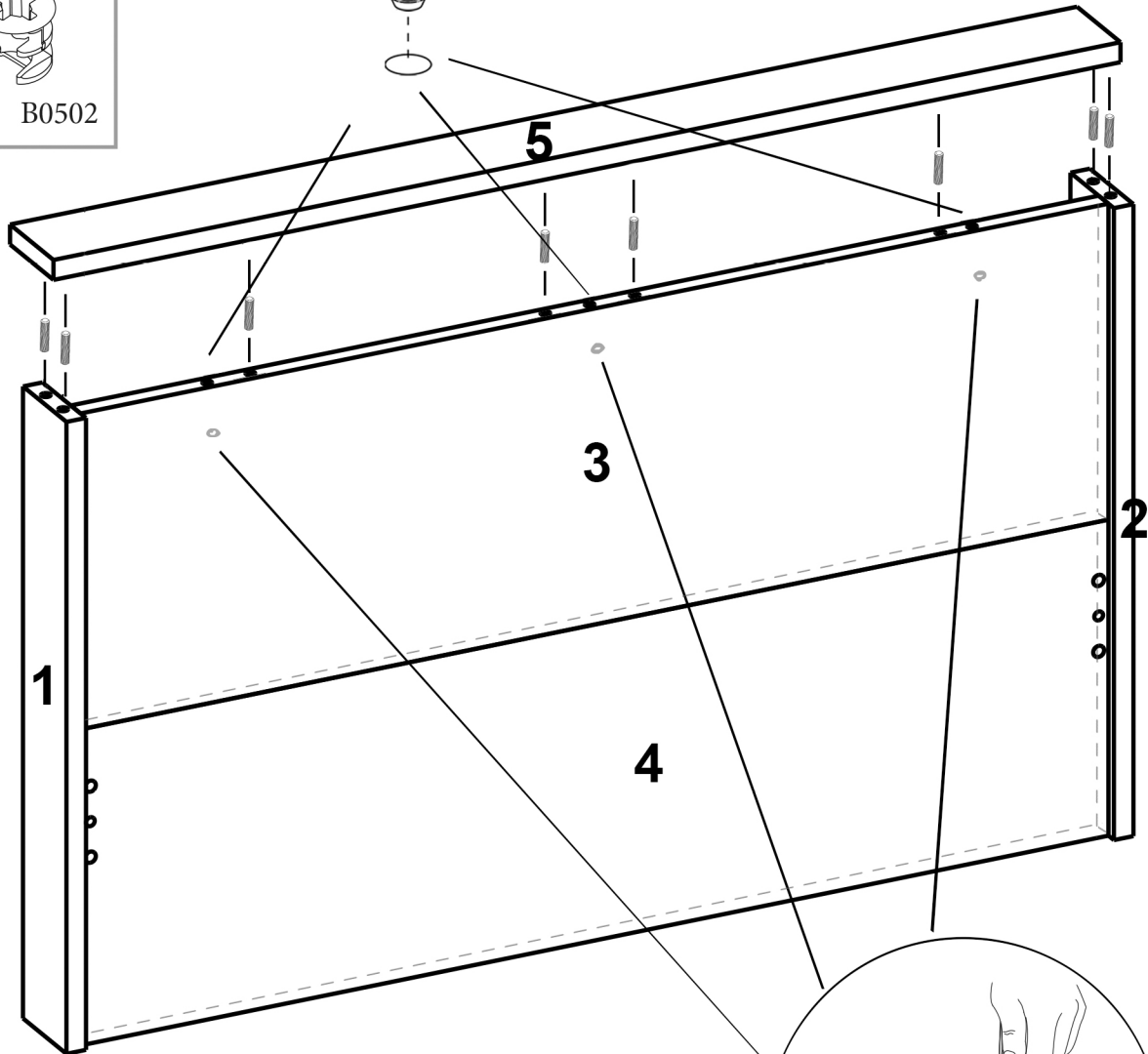
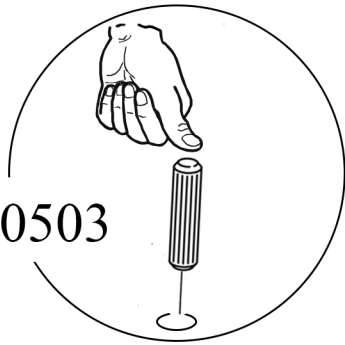
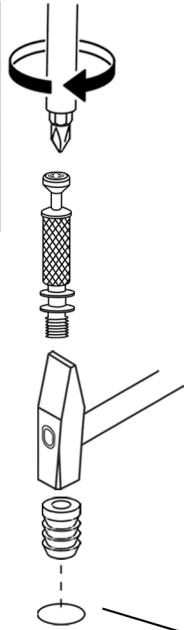

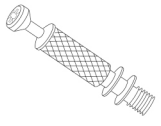

3x B0504



3x B0502



3x B0501

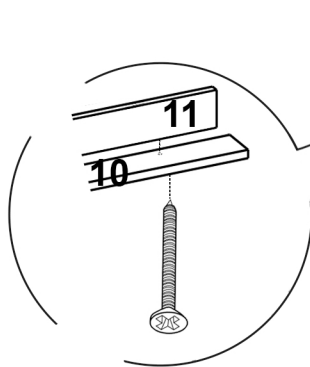
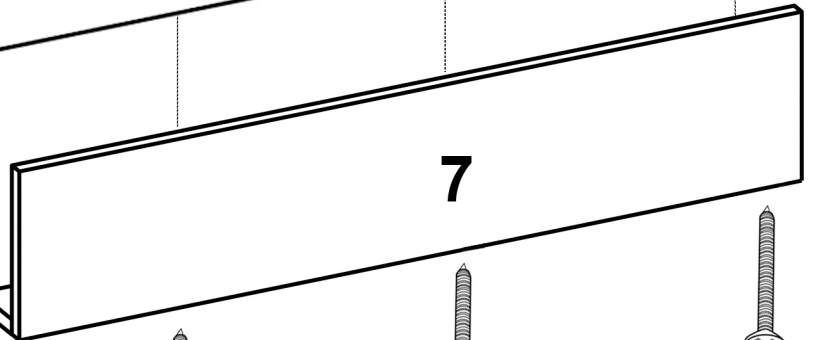
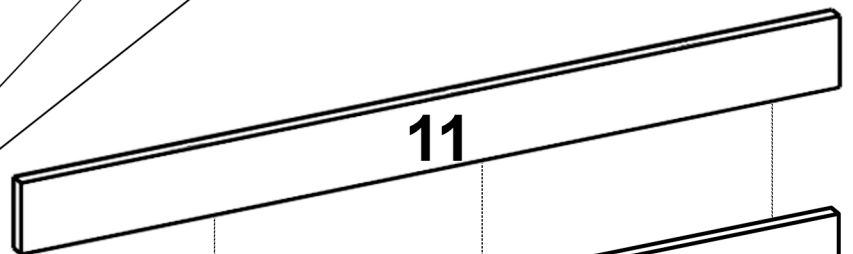
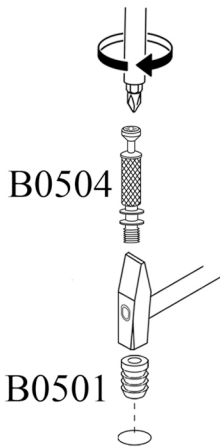
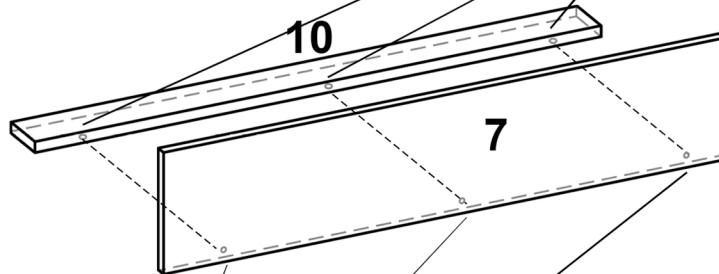
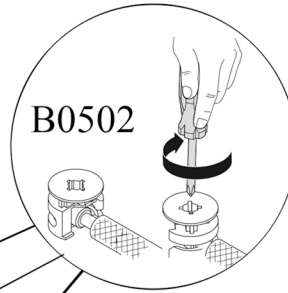

5/8

# HM4

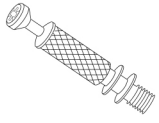
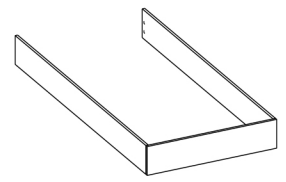

4x B0504

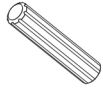

4x B0503



4x B0501



4x B0502

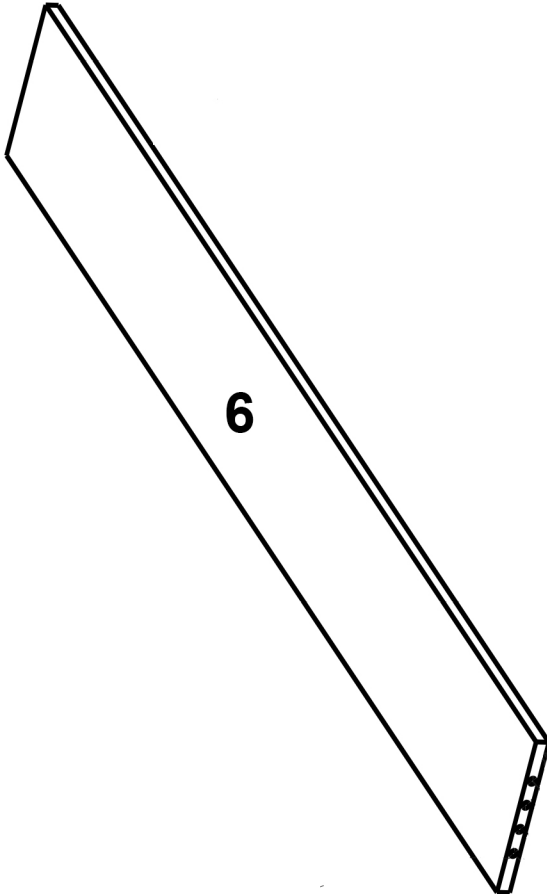

6

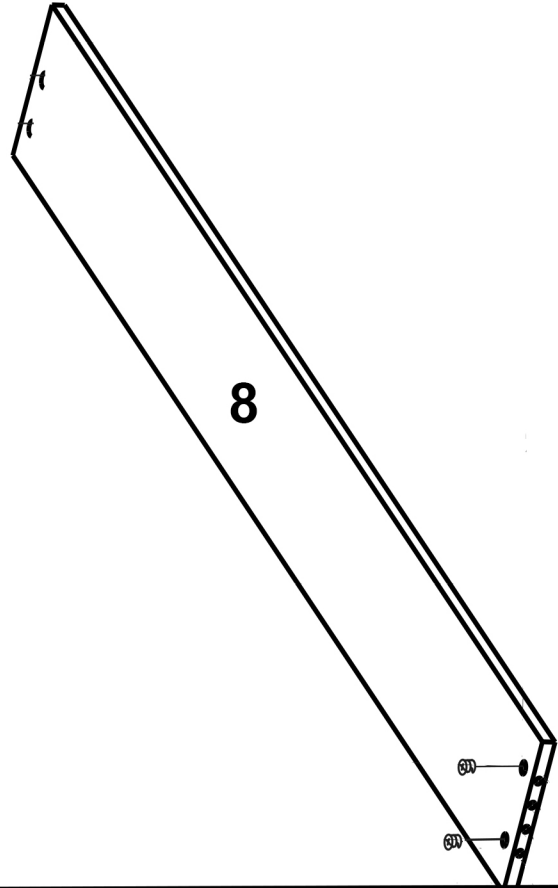

8

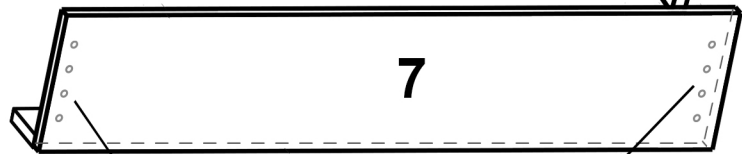

7

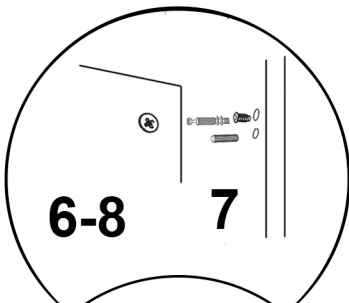

6-8

7

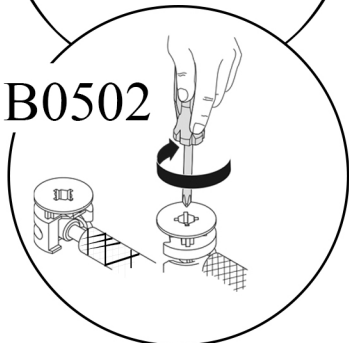

B0502

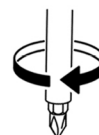

B0504

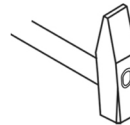

B0501

B0503

7

6/8

# HM4

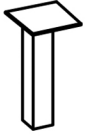
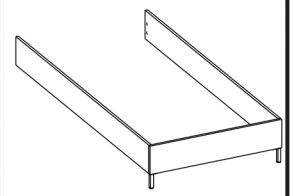

2x

D0154



6x

B0301

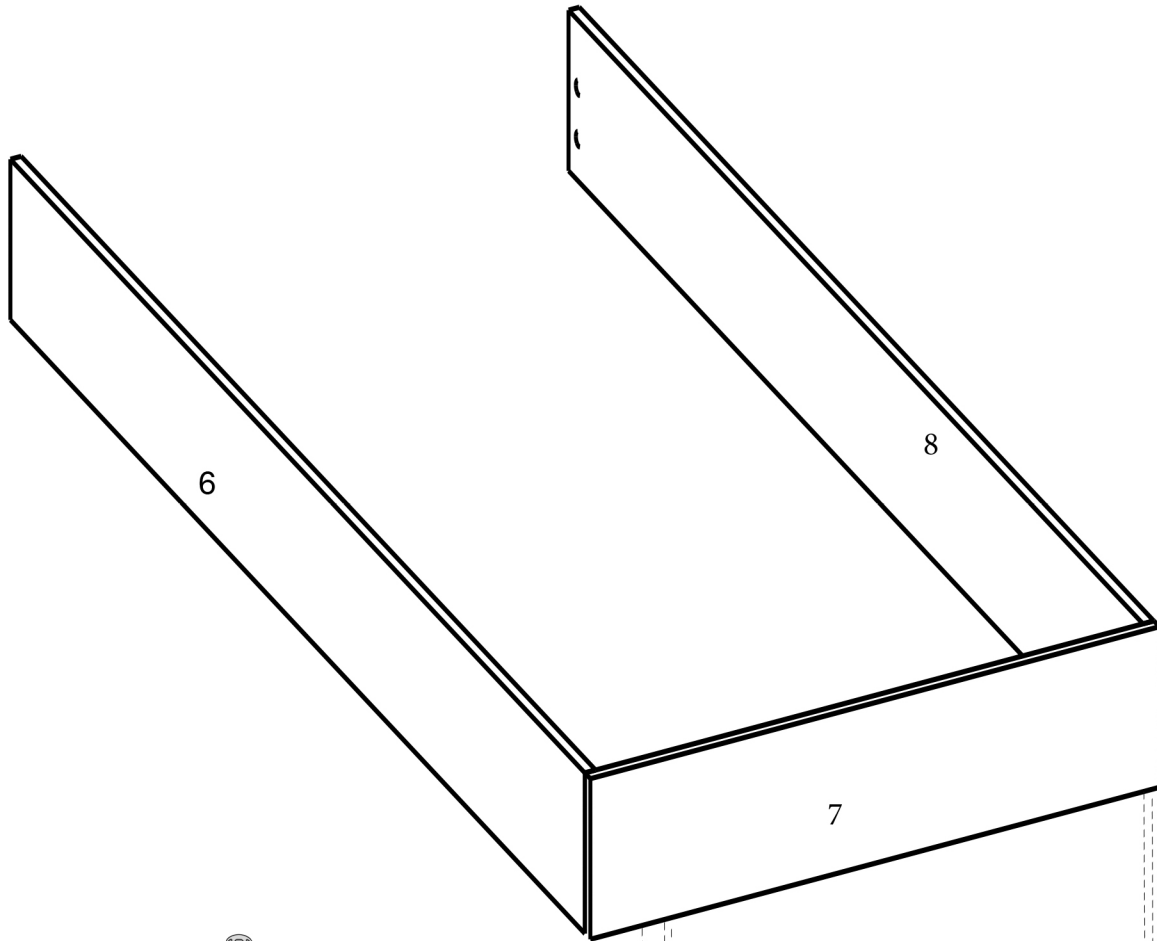

B0301

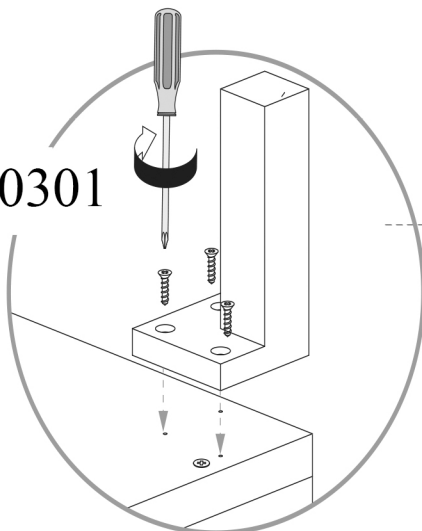

D0154

D0154

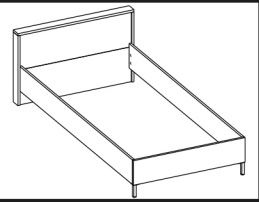

4x B0502

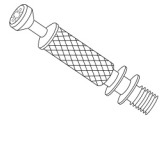

4x B0504



2x B0503



4x B0501



4x B0303

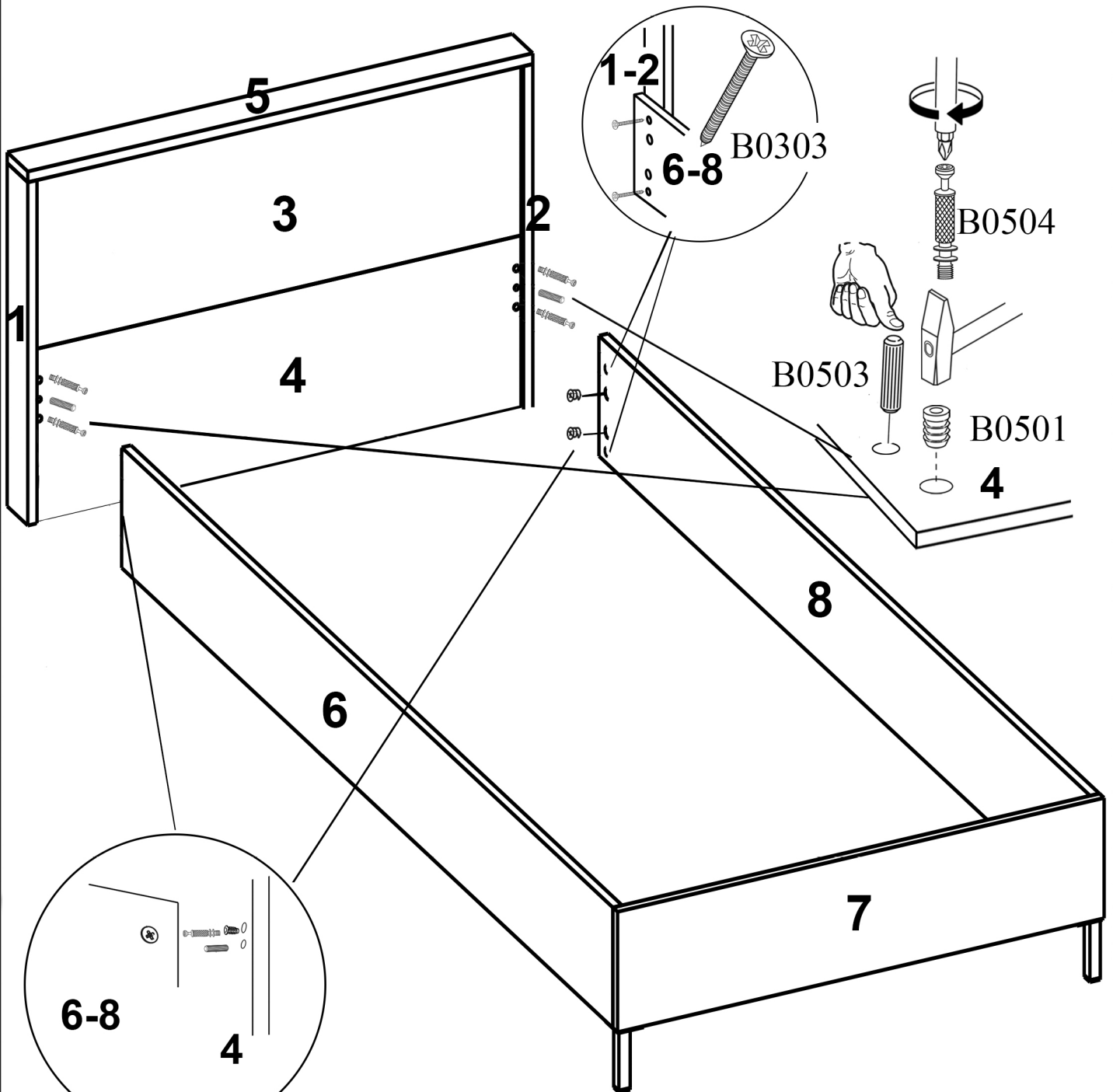

B0502

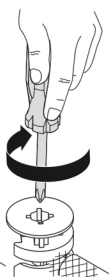
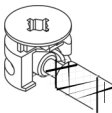



8/8

# HM4

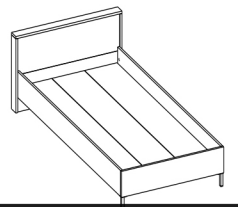

12x B0501



12x B0309



3x D0501

