

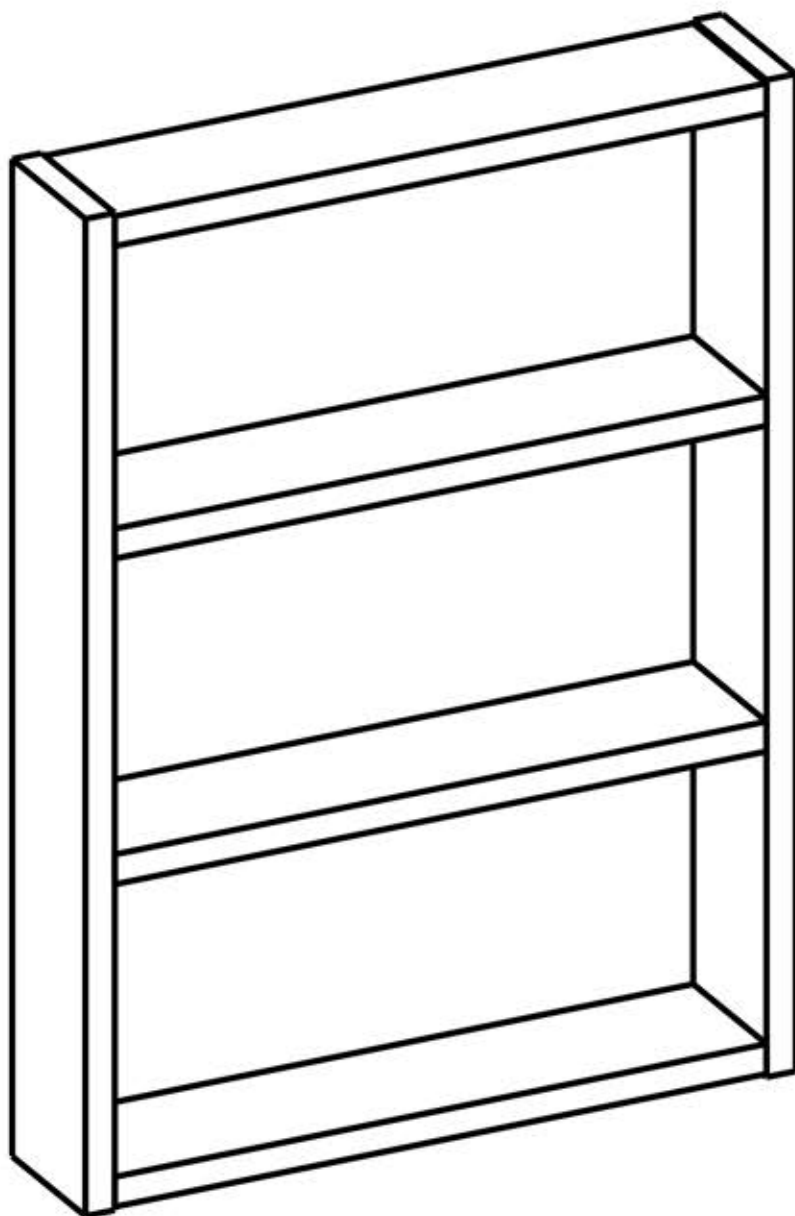



# PR1



	B0301 x4		B0304 x10		B0317 x2		B1306 x2
--	-------------	--	--------------	--	-------------	--	-------------

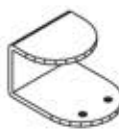
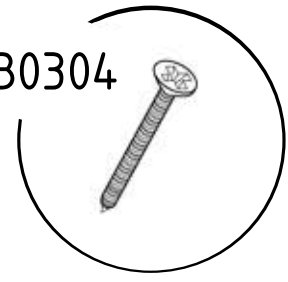
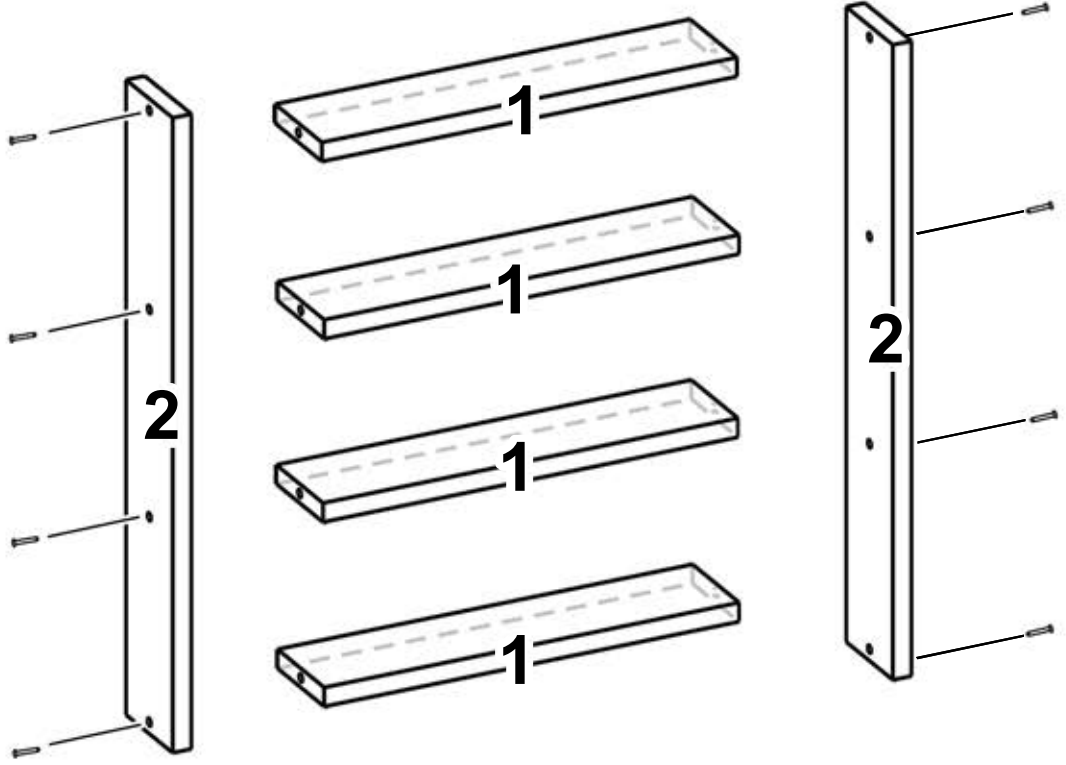

Icons illustrating the installation steps:

- Leveling the wall.
- Drilling holes.
- Hammering in the side panel.
- Attaching the bracket B1306 with screw B0301.
- Attaching the bracket B1306 with screw B0304.

