



### Part Name

P. No	Part Name	Piece	Diagram
1	BODY	1	
2	LEG	4	
3	SCREW	8	

1

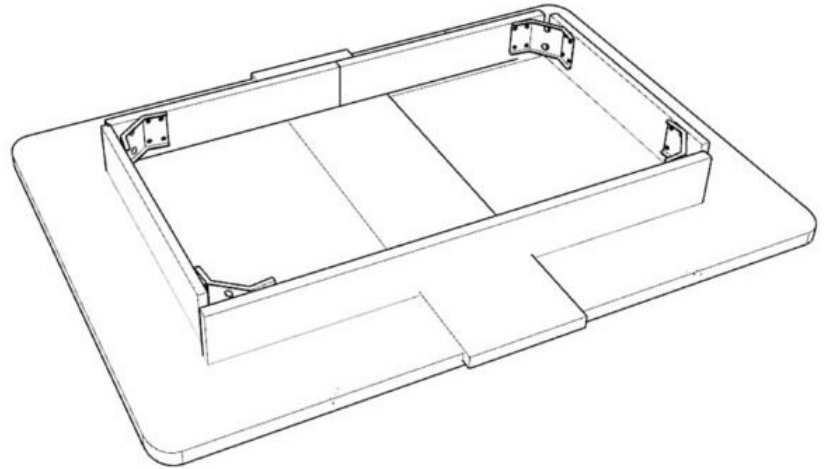

2

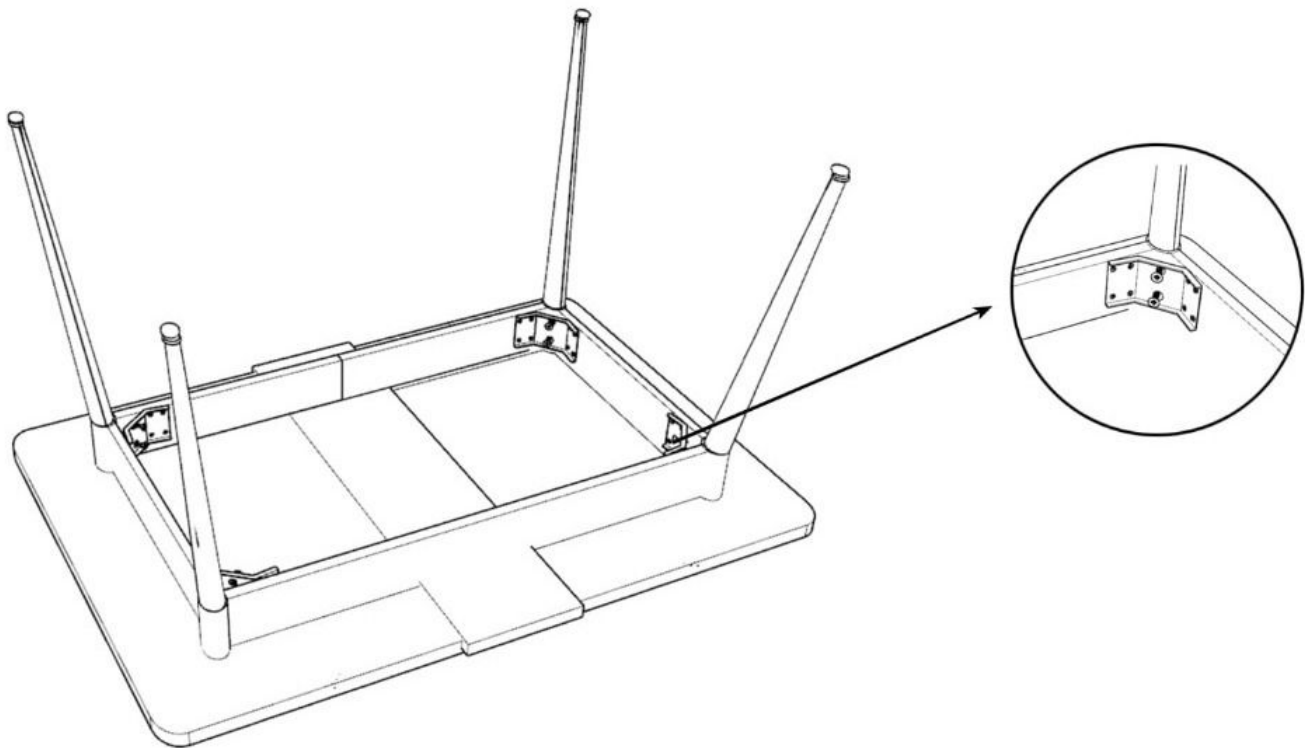

3

